

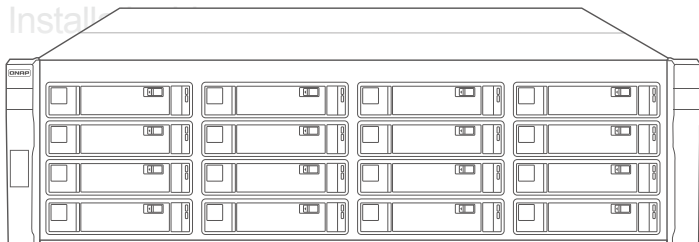

ES1640dc v2

Quick Installation Guide

快速安裝手冊 빠른 설치 설명서 Guía de Instalación Rápida
クイックインストールガイド Hızlı Kurulum Kılavuzu
คู่มือการติดตั้งแบบเร็ว Gyors telepítési útmutató
Instrukcja szybkiej instalacji Průvodce rychlou instalací
Kurzininstallationsanleitung 快速安裝指南
Guida di installazione rapida Pika-asennusopas
Краткое руководство по установке
Snabbinstallationsguide Guia de Instalação Rápida
Hurtiginstallasjonsveiledning Hurtig installationsvejle
Pika-asennusopas Installatiegids Snelle Installatiegids
Snelle Installatiegids



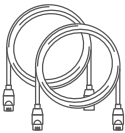
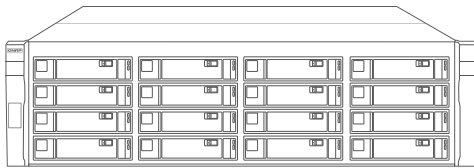

1GbE(RJ45) x 2
10GbE(RJ45) x 4



Console cable x 2



x 64



x 64



x 2



x 1



x 2



x 1

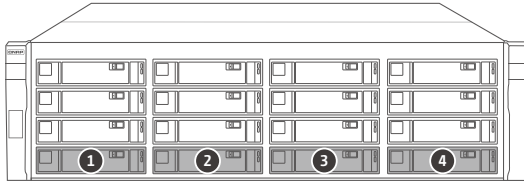

QES uses drive bays 1-4. QNAP recommends using SSD drives for QES – – – – – en

QES verwendet Laufwerksschächte 1-4. QNAP empfiehlt, SSD-Laufwerke für QES zu verwenden – – – – – de

QES utilise les baies de disques 1 à 4. QNAP recommande d'utiliser des lecteurs SSD pour QES – – – – – fr

QES usa vani unità 1-4. QNAP consiglia di utilizzare unità SSD per QES – – – – – it

QES usa bahías de unidades 1-4. QNAP recomienda el uso de unidades SSD para QES. – – – – – es

QES gebruikt de stations sleuven 1-4. QNAP adviseert om SSD-schijven te gebruiken voor QES – – – – – nl

QES använder diskfack 1-4. QNAP rekommenderar att SSD-diskar används med QES – – – – – sv

QES käyttää asemapaikkoja 1-4. QNAP suosittelee käyttämään SSD-asemia QESille – – – – – fi

QES bruger diskpladser 1 - 4. QNAP anbefaler brug af SSD-diske til QES – – – – – da

QES bruker diskluken 1-4. QNAP anbefaler å bruke SSD-disker for QES – – – – – no

QES usa baías de disco rígido 1-4. A QNAP recomienda usar discos rígidos SSD para QES – – – – – pt

QES использует отсеки для дисков 1-4. QNAP рекомендует использовать для QES диски SSD – – – – – ru

QES 使用硬碟插槽 1-4。QNAP 建議針對 QES 使用 SSD 硬碟 – – – – – zh

QES 使用硬碟架 1-4。QNAP 建议使用 SSD 硬盘安装 QES – – – – – cn

QES はドライブベイ 1-4 を使用します。QNAP は QES 用に SSD ドライブの使用を推奨します – – – – – ja

QES 는 드라이브 베이 1-4 를 사용합니다. QNAP 는 QES 에 SSD 드라이브를 사용할 것을 권장합니다 – – – – – ko

QES ใช้ช่องไดรฟ์ 1-4 QNAP ขอแนะนำให้ใช้ไดรฟ์ SSD สำหรับ QES – – – – – th

QES 1-4 sürücü bölmesi kullanır. QNAP QES için SSD sürücülerinin kullanılmasını önerir – – – – – tr

A QES az 1-4. meghajtóhelyet használja. A QNAP javasolja SSD-meghajtók használatát a QES-hez – – – – – hu

QES využívá přihrádky disků 1-4. Společnost QNAP doporučuje pro QES disky SSD – – – – – cs

System QES używa wnęk dysków 1-4. Firma QNAP zaleca używanie dysków SSD do obsługi systemu QES – – – – – pl

QES مع SSD تستخدم محركات الأقراص 1-4. توصي QNAP باستخدام محركات أقراص SSD مع – – – – – ar



HDD / SSD

<http://www.qnap.com/compatibility>

- All the drive data will be cleared upon SSD / HDD initialization ----- en
- Alle Laufwerksdaten werden bei SSD/HDD-Initialisierung gelöscht ----- de
- Toutes les données présentes sur les disques seront effacées lors de l'initialisation des SSD/HDD ----- fr
- Tutti i dati presenti verranno cancellati durante l'inizializzazione degli SSD / HDD ----- it
- Todos los datos del disco serán borrados con la inicialización del SSD / HDD ----- es
- Alle gegevens worden gewist tijdens de initialisatie van de SSD / HDD's ----- nl
- All data kommer att raderas när SSD / HDD initieras ----- sv
- SSD / HDD alustaminen poistaa kaikki tiedostot ----- fi
- Alle data på drevet vil blive ryddet efter initialisering af SSD / HDD ----- da
- All data vil bli slettet når SSD / HDD er initialisert ----- no
- Todos os dados do SSD / HDD serão apagados com a inicialização do SSD / HDD ----- pt
- После инициализации SSD/HDD все данные на нем будут удалены ----- ru
- 硬碟初始化時，所有資料皆會被清除 ----- zh
- 所有 SSD / HDD 上的数据都将会被清除 ----- cn
- SSD/HDD を初期化すると、すべてのデータが消去されます ----- ja
- SSD / HDD 를 초기화 시키면 드라이브의 모든 데이터가 손실됩니다 ----- ko
- ข้อมูลในไดรฟ์จะถูกลบออก เมื่อมีการตั้งค่าเริ่มต้น ----- th
- Kurulum başladığında SSD / HDD disk üzerinde ki tüm veri silinecektir ----- tr
- Minden korábbi adat törlődik az SSD / HDD-ről az első rendszerindítás során ----- hu
- Všetchna data na SSD / HDD budou smazána v důsledku inicializace ----- cs
- Podczas instalacji wszystkie dane na dyskach SSD / HDD zostaną usunięte ----- pl
- يتم مسح كل بيانات محرك الأقراص عند تهيئة HDD(قرص الحالة الصلبة)/SSD(محرك الأقراص الصلبة) ----- ar

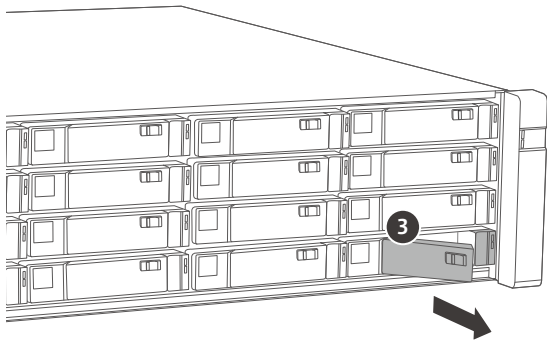
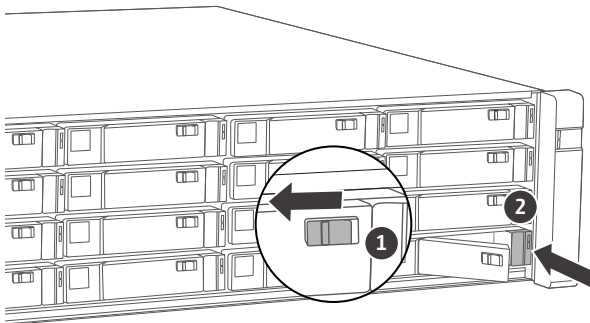

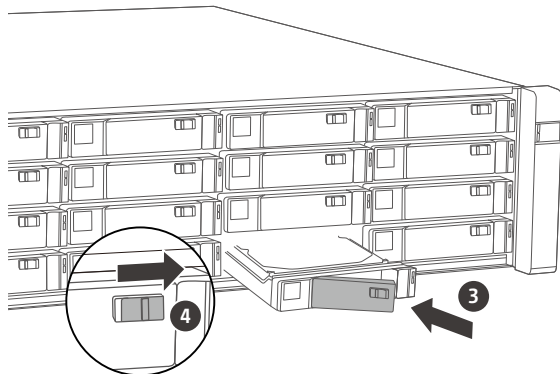
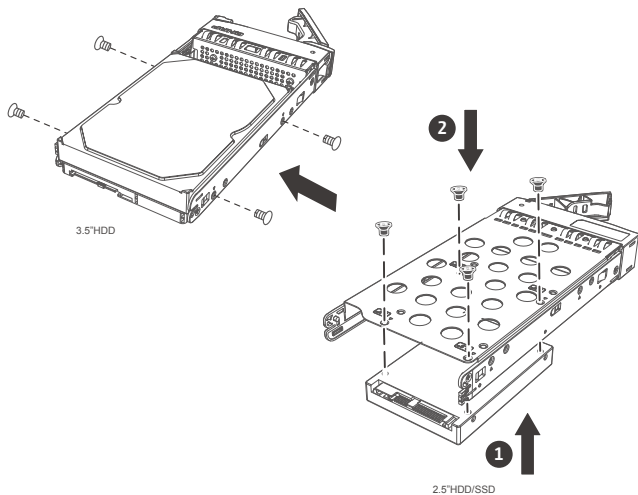

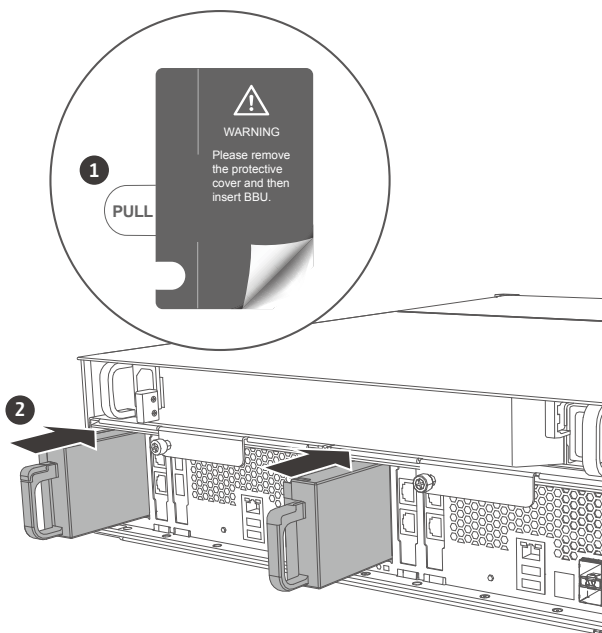

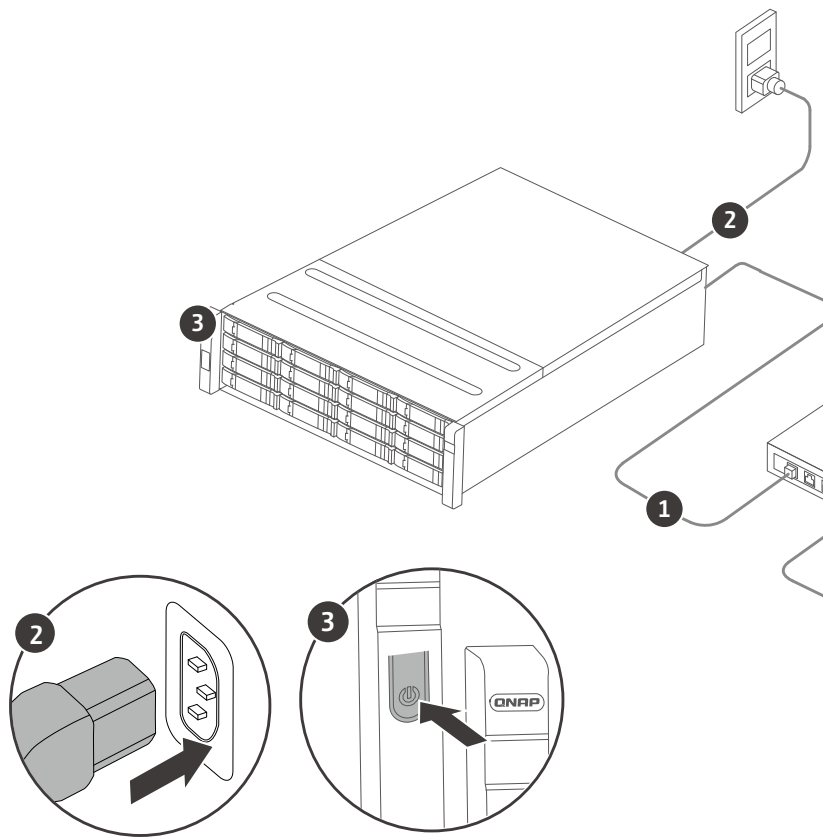

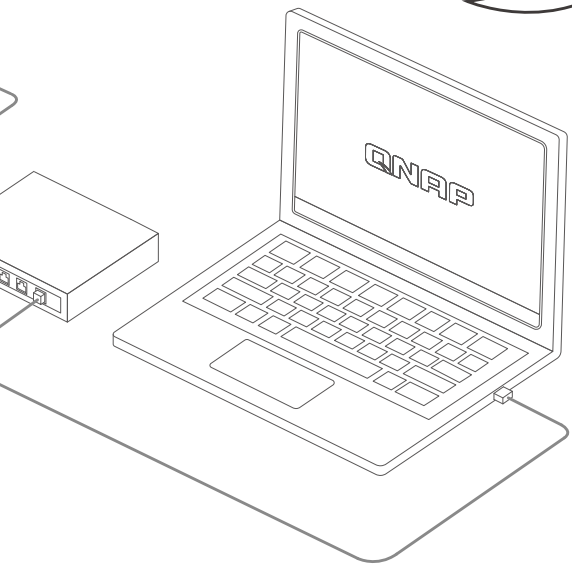
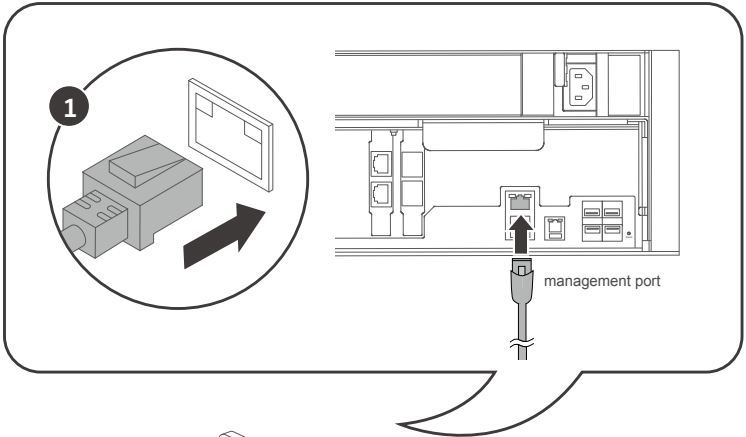



Qfinder Pro



<http://www.qnap.com/qfinderpro>



- Use Qfinder Pro to locate the NAS ----- en
- Verwenden Sie Qfinder Pro, um das NAS zu finden ----- de
- Utiliser Qfinder Pro pour localiser le NAS ----- fr
- Usare Qfinder Pro per individuare il NAS ----- it
- Usar Qfinder Pro para localizar el NAS ----- es
- Gebruik Qfinder Pro om de NAS te vinden ----- nl
- Använd Qfinder Pro för att hitta NAS:en ----- sv
- Etsi NAS käyttämällä Qfinder Prota ----- fi
- Brug Qfinder Pro til at finde NAS'en ----- da
- Bruk Qfinder Pro til å finne NAS-enheten ----- no
- Use o Qfinder Pro para localizar o NAS ----- pt
- Для поиска NAS воспользуйтесь Qfinder Pro ----- ru
- 使用 Qfinder Pro 搜尋 NAS ----- zh
- 使用 Qfinder Pro 定位 NAS ----- cn
- NAS を見つけるために Qfinder Pro を使用します ----- ja
- NAS 를 찾는 Qfinder Pro ----- ko
- ใช้ Qfinder Pro เพื่อระบุตำแหน่งของ NAS ----- th
- NAS'ı yerleştirmek için Qfinder Pro'yu kullanın ----- tr
- Használja a Qfinder Pro-t a NAS kereséséhez ----- hu
- Pro vyhledání NAS použijte nástroj Qfinder Pro ----- cs
- Użyj aplikacji Qfinder Pro do znalezienia serwera NAS ----- pl
- استخدم Qfinder Pro التحديد موقع وحدة التخزين الشبكي ----- ar

Quick Setup

QNAP

Products QTS 4.3 Surveillance Solutions Support Buy QIoT

Support

Quick Setup QNAP Enterprise-Class ES NAS Series

Enterprise ZFS NAS - Quick Setup



You can download the ES1640dc v2 Quick Setup Guide through this URL:www.qnap.com/tutorial/es-qsg en
 Sie können die Schnellstartanleitung ES1640dc v2 über diese URL herunterladen: www.qnap.com/tutorial/es-qsg de
 Vous pouvez télécharger le Guide d'installation rapide du ES1640dc v2 via cette URL : www.qnap.com/tutorial/es-qsg fr
 La guida sulla configurazione rapida di ES1640dc v2 è disponibile all'URL: www.qnap.com/tutorial/es-qsg it
 Puede descargar la Guía de configuración rápida de ES1640dc v2 desde esta URL: www.qnap.com/tutorial/es-qsg es
 U kunt de beknopte handleiding voor het instellen van ES1640dc v2 vinden op www.qnap.com/tutorial/es-qsg nl
 Du kan ladda ned ES1640dc v2 snabbinstallationsguide på denna URL:www.qnap.com/tutorial/es-qsg sv
 Voi tladata ES1640dc v2 -pikaoppaan tämän url-osoitteen kautta:www.qnap.com/tutorial/es-qsg fi
 Du kan downloade ES1640dc v2-hurtigvejledningen her URL:www.qnap.com/tutorial/es-qsg da
 Du kan laste ned ES1640dc v2 Veiledning for hurtiginstallasjon via denne URL-adressen: www.qnap.com/tutorial/es-qsg no
 Baixe o Guia de Configuração Rápida ES1640dc v2 através desta URL:www.qnap.com/tutorial/es-qsg pt
 Вы можете загрузить руководство по быстрой настройке (ES1640dc, версия 2) по этому URL-адресу: www.qnap.com/tutorial/es-qsg ru
 您可以前往以下網頁下載 ES1640dc v2 快速設定指南 : www.qnap.com/tutorial/es-qsg zh
 您可以通過此 URL 下載 ES1640dc v2 《快速安裝指南》: www.qnap.com/tutorial/es-qsg cn
 ES1640dc v2 クイック設定はこの URL:www.qnap.com/tutorial/es-qsg からダウンロードできません ja
 URL.www.qnap.com/tutorial/es-qsg 를 통해 ES1640dc v2 빠른 설정 가이드를 다운로드할 수 있습니다 ko
 คุณสามารถดาวน์โหลดคู่มือการติดตั้งพ่วง ES1640dc เวอร์ชัน 2 ได้ที่ URL นี้: www.qnap.com/tutorial/es-qsg th
 ES1640dc v2 Hızlı Kurulum Kılavuzunu bu URL'den indirebilirsiniz: www.qnap.com/tutorial/es-qsg tr
 Az ES1640dc v2 gyorsbeállítás útmutatót az alábbi URL-címen töltheti le: www.qnap.com/tutorial/es-qsg hu
 Stručného průvodce nastavením ES1640dc v2 najdete na adrese: www.qnap.com/tutorial/es-qsg cs
 Przewodnik szybkiej instalacji dla modelu ES1640dc v2 jest dostępny pod adresem www.qnap.com/tutorial/es-qsg pl
www.qnap.com/tutorial/es-qsg: يمكنك تنزيل دليل إعداد ES1640dc v2 من خلال العنوان التالي ar

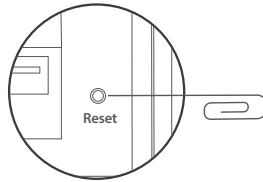
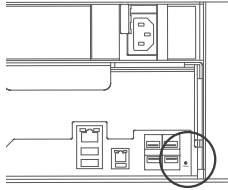

- To revert to the default password, use a pin to press the Reset button for three seconds or until you hear a short beep – en
- Zum Rücksetzen auf das Standardkennwort müssen Sie die Reset-Taste drei Sekunden lang oder bis zur Ausgabe eines kurzen Signaltons mit einem schmalen spitzen Gegenstand drücken – de
- Pour revenir au mot de passe par défaut, utilisez une pointe pour appuyer sur le bouton Réinitialiser pendant trois secondes ou jusqu'à ce que vous entendiez un bip court – fr
- Per tornare alla password predefinita, usare uno spillo per premere il tasto Reset per tre secondi o fino a che non si sente il segnale acustico – it
- Para restaurar la contraseña predeterminada, utilice un objeto puntiagudo para pulsar el botón Restablecer durante tres segundos o hasta que escuche un pitido corto – es
- Om terug te keren naar het oude wachtwoord, gebruikt u een pennenetje om de Reset-knop drie seconden in te drukken of tot u een korte pieptoon hoort – nl
- För att återställa standardlösenordet , använd en nål för att trycka in återställningsknappen i tre sekunder eller tills du hör ett kort pip – sv
- Palataksesi oletussalasanaan, paina neulalla nollauspainiketta kolme sekuntia, kunnes kuulet lyhyen merkkiäänen – fi
- For at gendanne til standardadgangskoden, skal du bruge en clips til at trykke på nulstillingsknappen i tre sekunder eller indtil du hører et kort pip – da
- For å gå tilbake til standardpassordet kan du bruke en nål til å trykke inne Reset-knappen i tre sekunder eller til du hører et kort pip – no
- Para reverter para a senha padrão, utilize um pino para pressionar o botão de Reset por três segundos ou até que você ouça um bipe curto – pt
- Чтобы восстановить пароль по умолчанию, булавкой держите нажатой кнопку сброса три секунды или до подачи короткого звукового сигнала – ru
- 恢復預設密碼的方法：用迴紋針尖壓著「重設」鈕三秒鐘，直到聽見短促嗶聲為止 – zh
- 欲恢复到默认密码，请用针状物抵按 Reset 键 3 秒或直至听见短促“哔”声 – cn
- 既定のパスワードに戻すには、ピンを利用してリセットボタンを 3 秒間（あるいは、ピー音が短く鳴るまで）押します – ja
- 기본 비밀번호로 되돌리려면 Reset(리셋) 버튼을 핀으로 3 초간 또는 짧은 경고음이 울릴 때까지 누르고 있으면 됩니다 – ko
- หากต้องการกลับไปใช้รหัสผ่านค่าเริ่มต้น ให้ใช้เข็มกดปุ่มรีเซ็ตเป็นเวลา 3 วินาที หรือจนกว่าคุณจะได้ยินเสียงสัญญาณเตือนสั้น ๆ – th
- Varsayılan şifreye dönmek amacıyla, Sıfırla düğmesine üç saniye boyunca veya kısa bir sesli uyan duyana kadar basmak için bir iğne kullanın – tr
- Az alapértelmezett jelszó visszaállításához nyomja meg a Reset gombot a túvel három másodpercig vagy amíg egy rövid hangjelzést nem hall – hu
- Chcete-li obnovit původní heslo, pomocí tenkého a špičatého předmětu stiskněte a podržte resetovací tlačítko tři sekundy nebo do zaznění krátkého pípnutí – cs
- Aby przywrócić hasło domyślne, należy za pomocą szpilki wcisnąć przycisk Reset i przytrzymać go przez trzy sekundy, aż do usłyszenia krótkiego sygnału – pl
- لاستعادة كلمة المرور الافتراضية: استخدم دبوسًا للضغط على زر Reset (إعادة الضبط) لمدة ثلاث ثوانٍ أو حتى تسمع صوت صفير قصير – ar



This device complies with Part 15 of the FCC Rules. Operation is subject to the following two conditions:

1. This device may not cause harmful interference.
2. This device must accept any interference received, including interference that may cause undesired operation.

FCC Class A Notice:

This equipment has been tested and found to comply with the limits for a Class A digital device, pursuant to Part 15 of the FCC Rules. These limits are designed to provide reasonable protection against harmful interference when the equipment is operated in a commercial environment. This equipment generates, uses, and can radiate radio frequency energy, and if not installed and used in accordance with the instruction manual, may cause harmful interference to radio communications. Operation of this equipment in a residential area is likely to cause harmful interference, in which case the user will be required to correct the interference at his own expense.

Modifications: Any modifications made to this device that are not approved by QNAP Systems, Inc. may void the authority granted to the user by the FCC to operate this equipment.



This device complies with CE compliance Class A.



According to the requirement of the WEEE legislation the following user information is provided to customers for all branded QNAP Electronics products subject to the WEEE directive.

This symbol on the product or on its packaging indicates that this product must not be disposed of with your other household waste. Instead, it is your responsibility to dispose of your waste equipment by handing it over to a designated collection point for the recycling of waste electrical and electronic equipment. The separate collection and recycling of your waste equipment at the time of disposal will help to conserve natural resources and ensure that it is recycled in a manner that protects human health and the environment. For more information about where you can drop off your waste equipment for recycling, please contact your local city office, your household waste disposal service or the shop where you purchased the product.



更多關於安全、法規、與環境法令遵循相關的資訊，請參閱以下網址 www.qnap.com/regulatory/



start.qnap.com



helpdesk.qnap.com



docs.qnap.com



www.qnap.com/download

QNAP

Printed in Taiwan
P/N: 51000-024427-RS