

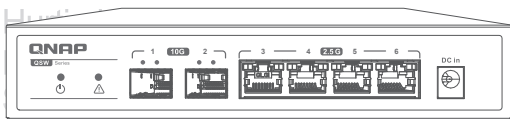

QSW-2104-2S/2T

Quick Installation Guide

快速安裝手冊 빠른 설치 설명서 Guía de Instalación Rápida
クイックインストールガイド Hızlı Kurulum Kılavuzu
คู่มือการติดตั้งแบบเร็ว Gyors telepítési útmutató
Instrukcja szybkiej instalacji Průvodce rychlou in
Kurzinstructionsanleitung 快速安裝指南
Guida di installazione rapida Pika-asennusopas
Краткое руководство по установке
Snabbinstallationsguide
Guia de Instalação Rápida
Hurtiginstallasjonsveiledning



QSW-2104-2S

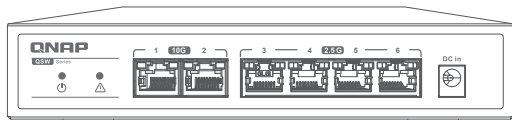

QSW-2104-2T

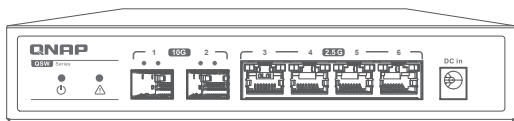
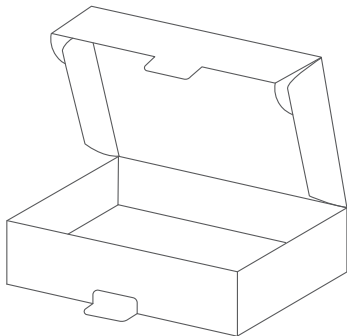

QSW-2104-2S

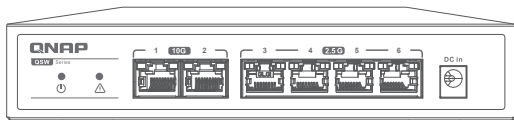

QSW-2104-2T

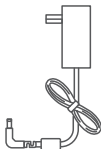

Power supply



Bracket screws



Anchors



Foot pads



Quick installation guide

Specifications

Model	QSW-2104-2S	QSW-2104-2T
Dimensions (H x W x D)	34 x 180 x 145 mm	
Net weight	713g	722g
Input voltage range	100–240VAC	
Switching bandwidth	60 Gbps	
10GbE SFP+ ports	2	-
10GbE RJ45 ports	-	2
2.5GbE RJ45 ports	4	4
Operating temperature	0°C–40°C (32°F –104°F)	
Relative humidity	10% to 90% (non-condensing)	

QSW-2104-2S

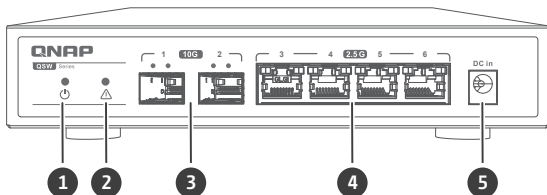

1. Power LED	4. 2.5GbE RJ45 ports
2. Loop indicator	5. Power input
3. 10GbE SFP+ ports	

QSW-2104-2T

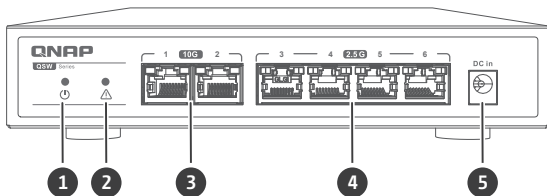

1. Power LED	4. 2.5GbE RJ45 ports
2. Loop indicator	5. Power input
3. 10GbE RJ45 ports	

LED Behavior

LED	Status	Description
Power	Green	Device is on
	Off	Device is off
Loop indicator	Off	No loop
	Red and flashing with looping ports	Loop occurs
10GbE SFP+ ports	Green(left)	Link is operating at 10 Gbps, flashing: link up, off: no link, flashing with loop indicator: port loop
	Amber(right)	Link is operating at 1 Gbps, flashing: link up, off: no link.
10GbE RJ45 ports	Green(left)	Link is operating at 10 Gbps, flashing: link up, off: no link, flashing with loop indicator: port loop
	Amber(right)	Link is operating at 5G/2.5G/1G/100M bps, flashing: link up, off: no link.
2.5GbE RJ45 ports	Green(left)	Link is operating at 2.5 Gbps, flashing: link up, off: no link, flashing with loop indicator: port loop
	Amber(right)	Link is operating at 1G/100M bps, flashing: link up, off: no link.

QSW-2104-2S

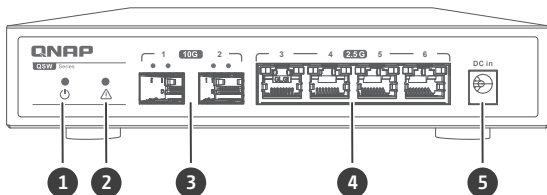

1. Betriebsanzeige-LED	4. 2.5GbE RJ45 ports
2. Schleifenanzeige	5. Anschluss für Netzkabel
3. 10GbE SFP+ ports	

QSW-2104-2T

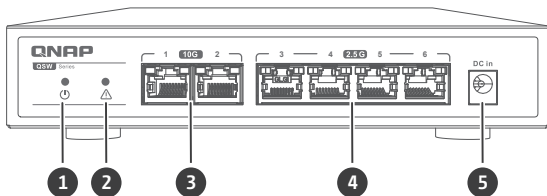

1. Betriebsanzeige-LED	4. 2.5GbE RJ45 ports
2. Schleifenanzeige	5. Anschluss für Netzkabel
3. 10GbE RJ45 ports	

LED Verhalten

LED	Status	Beschreibung
Ein/Aus	Grün	Gerät ist eingeschaltet
	Aus	Gerät ist ausgeschaltet
Schleifenanzeige	Aus	Keine Schleife
	Rot und blinkend mit Ports in Schleife	Schleife tritt auf
10GbE SFP+ Ports	Grün (Links)	Link arbeitet mit 10 Gbps, blinkend: Link aufgebaut, aus: kein Link, blinkend mit Schleifenanzeige: Port Schleife
	Orange (Rechts)	Link arbeitet mit 1 Gbps, blinkend: Link aufgebaut, aus: kein Link.
10GbE RJ45 Ports	Grün (Links)	Link arbeitet mit 10 Gbps, blinkend: Link aufgebaut, aus: kein Link, blinkend mit Schleifenanzeige: Port Schleife
	Orange (Rechts)	Link arbeitet mit 5G/2,5G/1G/100 Mbps, blinkend: Link aufgebaut, aus: kein Link.
2,5GbE RJ45 Ports	Grün (Links)	Link arbeitet mit 2,5 Gbps, blinkend: Link aufgebaut, aus: kein Link, blinkend mit Schleifenanzeige: Port Schleife
	Orange (Rechts)	Link arbeitet mit 1G/100 Mbps, blinkend: Link aufgebaut, aus: kein Link.

QSW-2104-2S

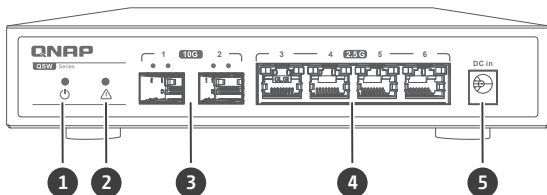

1. Témoin d'alimentation	4. Ports 2,5GbE RJ45
2. Indicateur de boucle	5. Entrée d'alimentation
3. Ports 10GbE SFP+	

QSW-2104-2T

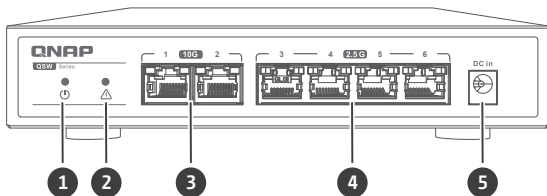

1. Témoin d'alimentation	4. Ports 2,5GbE RJ45
2. Indicateur de boucle	5. Entrée d'alimentation
3. Ports 10GbE RJ45	

Comportement de la LED

LED	État	Description
Alimentation	Verte	L'appareil est activé
	Désactivé	L'appareil est désactivé
Indicateur de boucle	Désactivé	Aucune boucle
	Rouge et clignotant avec les ports de boucle	Une boucle se produit
Ports 10GbE SFP+	Verte (gauche)	La liaison fonctionne à 10 Gbit/s, clignotant : liaison montante, désactivé : pas de liaison, clignotant avec indicateur de boucle : boucle du port
	Ambre (droite)	La liaison fonctionne à 1 Gbit/s, clignotant : liaison montante, désactivé : pas de liaison.
Ports 10GbE RJ45	Verte (gauche)	La liaison fonctionne à 10 Gbit/s, clignotant : liaison montante, désactivé : pas de liaison, clignotant avec indicateur de boucle : boucle du port
	Ambre (droite)	La liaison fonctionne à 5/2,5/1 Gbit/s et 100 Mbit/s, clignotant : liaison montante, désactivé : pas de liaison.
Ports 2,5GbE RJ45	Verte (gauche)	La liaison fonctionne à 2,5 Gbit/s, clignotant : liaison montante, désactivé : pas de liaison, clignotant avec indicateur de boucle : boucle du port
	Ambre (droite)	La liaison fonctionne à 1 Gbit/100 Mbit/s, clignotant : liaison montante, désactivé : pas de liaison.



QSW-2104-2S

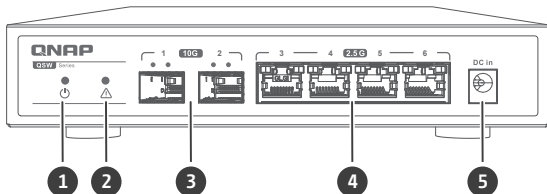

1. LED di alimentazione	4. Porte 2,5GbE RJ45
2. Indicatore loop	5. Ingresso alimentazione
3. Porte 10GbE SFP+	

QSW-2104-2T

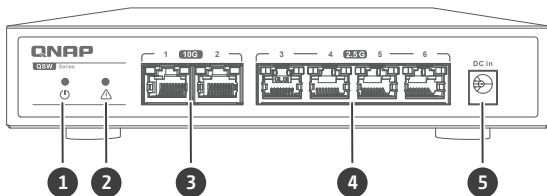

1. LED di alimentazione	4. Porte 2,5GbE RJ45
2. Indicatore loop	5. Ingresso alimentazione
3. Porte 10GbE RJ45	

Comportamento del LED

LED	Stato	Descrizione
Alimentazione	Verde	Dispositivo acceso
	Disattivo	Dispositivo spento
Indicatore loop	Disattivo	Nessun loop
	Rosso e lampeggiante con porte in loop	Loop in esecuzione
Porte 10GbE SFP+	Verde (Sinistra)	Collegamento operativo a 10 Gbps, lampeggiante: collegamento attivo, spento: nessun collegamento, lampeggiante con indicatore loop: loop porta
	Ambra (Destra)	Collegamento operativo a 1 Gbps, lampeggiante: collegamento attivo, spento: nessun collegamento.
Porte 10GbE RJ45	Verde (Sinistra)	Collegamento operativo a 10 Gbps, lampeggiante: collegamento attivo, spento: nessun collegamento, lampeggiante con indicatore loop: loop porta
	Ambra (Destra)	Collegamento operativo a 5G/2,5G/1G/100 Mbps, lampeggiante: collegamento attivo, spento: nessun collegamento.
Porte 2,5GbE RJ45	Verde (Sinistra)	Collegamento operativo a 2,5 Gbps, lampeggiante: collegamento attivo, spento: nessun collegamento, lampeggiante con indicatore loop: loop porta
	Ambra (Destra)	Collegamento operativo a 1G/100 Mbps, lampeggiante: collegamento attivo, spento: nessun collegamento.

QSW-2104-2S

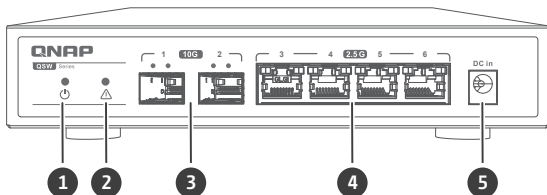

1. LED de alimentación	4. Puertos 2,5GbE RJ45
2. Indicador de bucle	5. Entrada de alimentación
3. Puertos 10 GbE SFP+	

QSW-2104-2T

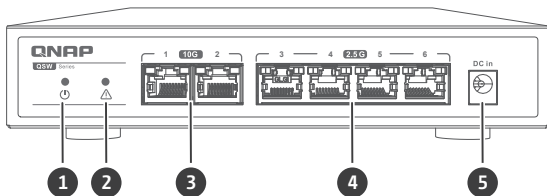

1. LED de alimentación	4. Puertos 2,5GbE RJ45
2. Indicador de bucle	5. Entrada de alimentación
3. Puertos 10GbE RJ45	

Comportamiento del LED

LED	Estado	Descripción
Alimentación	Verde	El dispositivo está encendido
	Desactivado	El dispositivo está apagado
Indicador de bucle	Desactivado	Sin bucle
	Rojo y parpadeante con puertos en bucle	Ocurre un bucle
Puertos 10 GbE SFP+	Verde (izquierda)	La conexión está funcionando a 10 Gbps, parpadeante: conexión establecida, apagado: sin conexión, parpadeante con indicador de bucle: bucle de puerto
	Ámbar (derecha)	La conexión está funcionando a 1 Gbps, parpadeante: conexión establecida, apagado: sin conexión.
Puertos 10GbE RJ45	Verde (izquierda)	La conexión está funcionando a 10 Gbps, parpadeante: conexión establecida, apagado: sin conexión, parpadeante con indicador de bucle: bucle de puerto
	Ámbar (derecha)	La conexión está funcionando a 5G/2,5G/1G/100M bps, parpadeante: conexión establecida, apagado: sin conexión.
Puertos 2,5GbE RJ45	Verde (izquierda)	La conexión está funcionando a 2,5 Gbps, parpadeante: conexión establecida, apagado: sin conexión, parpadeante con indicador de bucle: bucle de puerto
	Ámbar (derecha)	La conexión está funcionando a 1G/100M bps, parpadeante: conexión establecida, apagado: sin conexión.

TW

QSW-2104-2S

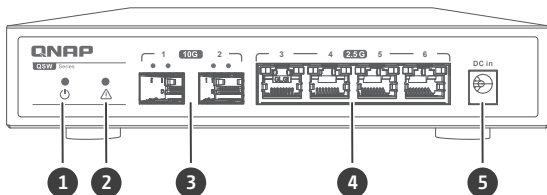

1. 電源 LED 燈	4. 2.5GbE RJ45 埠
2. 迴圈指示燈	5. 電源輸入
3. 10GbE SFP+ 埠	

QSW-2104-2T

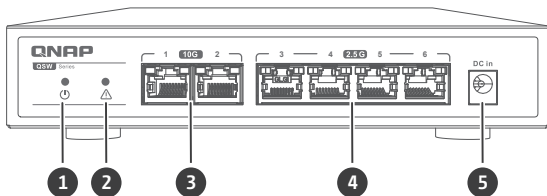

1. 電源 LED 燈	4. 2.5GbE RJ45 埠
2. 迴圈指示燈	5. 電源輸入
3. 10GbE RJ45 埠	

LED 燈號

LED	狀態	說明
電源	綠燈	裝置開機
	關閉	裝置關機
迴圈指示燈	關閉	無迴圈
	迴圈連接埠閃爍紅燈	形成迴圈
10GbE SFP+ 埠	綠燈 (左)	連線速度為 10 Gbps ; 閃爍 : 已連線 ; 熄滅 : 無連線 ; 迴圈指示燈閃爍 : 連接埠形成迴圈
	琥珀色燈 (右)	連線速度為 1 Gbps ; 閃爍 : 已連線 ; 熄滅 : 無連線。
10GbE RJ45 埠	綠燈 (左)	連線速度為 10 Gbps ; 閃爍 : 已連線 ; 關閉 : 無連線 ; 迴圈指示燈閃爍 : 連接埠形成迴圈
	琥珀色燈 (右)	連線速度為 5G/2.5G/1G/100 Mbps ; 閃爍 : 已連線 ; 熄滅 : 無連線。
2.5GbE RJ45 埠	綠燈 (左)	連線速度為 2.5 Gbps ; 閃爍 : 已連線 ; 熄滅 : 無連線 ; 迴圈指示燈閃爍 : 連接埠形成迴圈
	琥珀色燈 (右)	連線速度為 1G/100M bps ; 閃爍 : 已連線 ; 熄滅 : 無連線。

CN

QSW-2104-2S

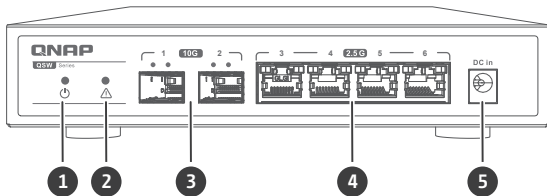

1. 电源 LED	4. 2.5GbE RJ45 端口
2. 环路指示灯	5. 电源输入
3. 10GbE SFP+ 端口	

QSW-2104-2T

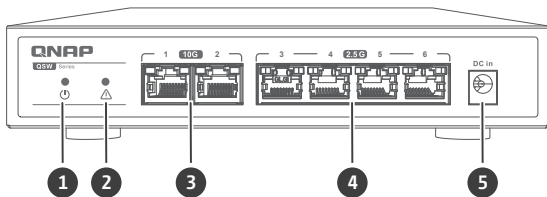

1. 电源 LED	4. 2.5GbE RJ45 端口
2. 环路指示灯	5. 电源输入
3. 10GbE RJ45 端口	

LED 行为

LED	状态	描述
电源	绿色	设备开机
	熄灭	设备关机
环路指示灯	熄灭	无环路
	环路端口红色闪烁	发生环路
10GbE SFP+ 端口	绿色 (左)	链路以 10 Gbps 的速度运行 · 闪烁: 链路正常 · 熄灭: 无链路 · 环路指示灯闪烁: 端口环路
	琥珀色 (右)	链路以 1 Gbps 的速度运行 · 闪烁: 链路正常; 熄灭: 无链路。
10GbE RJ45 端口	绿色 (左)	链路以 10 Gbps 的速度运行 · 闪烁: 链路正常 · 熄灭: 无链路 · 环路指示灯闪烁: 端口环路
	琥珀色 (右)	链路以 5G/2.5G/1G/100M bps 的速度运行 · 闪烁: 链路正常; 熄灭: 无链路。
2.5GbE RJ45 端口	绿色 (左)	链路以 2.5 Gbps 的速度运行 · 闪烁: 链路正常 · 熄灭: 无链路 · 环路指示灯闪烁: 端口环路
	琥珀色 (右)	链路以 1G/100M bps 的速度运行 · 闪烁: 链路正常; 熄灭: 无链路。

QSW-2104-2S

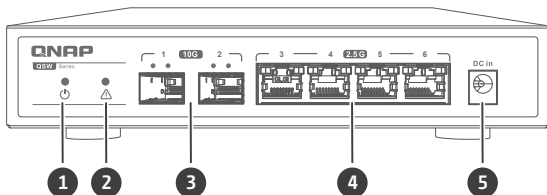

1. 電源 LED	4. 2.5GbE RJ45 ポート
2. ループインジケータ	5. 電源入力
3. 10GbE SFP+ ポート	

QSW-2104-2T

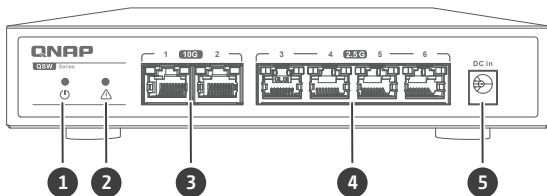

1. 電源 LED	4. 2.5GbE RJ45 ポート
2. ループインジケータ	5. 電源入力
3. 10GbE RJ45 ポート	

LED の動作

LED	状態	説明
電源	緑色	デバイスがオンです
	オフ	デバイスがオフです
ループインジケータ	オフ	ループなし
	ループポートで赤く点滅	ループ発生
10GbE SFP+ ポート	緑色 (左)	リンクは 10Gbps で動作しています。点滅：リンク起動、オフ：リンクなし、ループインジケータで点滅：ポートループ
	琥珀色 (右)	リンクは 1Gbps で動作しています。点滅：リンク起動、オフ：リンクなし。
10GbE RJ45 ポート	緑色 (左)	リンクは 10Gbps で動作しています。点滅：リンク起動、オフ：リンクなし、ループインジケータで点滅：ポートループ
	琥珀色 (右)	リンクは 5G/2.5G/1G/100M で動作しています。点滅：リンク起動、オフ：リンクなし。
2.5GbE RJ45 ポート	緑色 (左)	リンクは 2.5Gbps で動作しています。点滅：リンク起動、オフ：リンクなし、ループインジケータで点滅：ポートループ
	琥珀色 (右)	リンクは 1G/100Mbps で動作しています。点滅：リンク起動、オフ：リンクなし。

TH

QSW-2104-2S

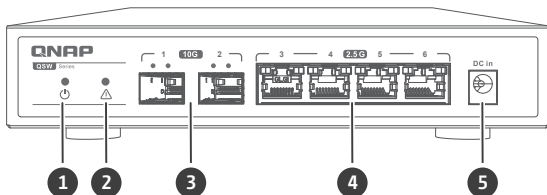

1. ไฟ LED พลังงาน	4. พอร์ต 2.5Gb RJ45
2. ไฟแสดงผลลูป	5. อินพุตพลังงาน
3. พอร์ต 10Gb SFP+	

QSW-2104-2T

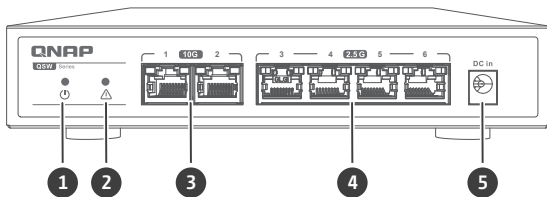

1. ไฟ LED พลังงาน	4. พอร์ต 2.5Gb RJ45
2. ไฟแสดงผลลูป	5. อินพุตพลังงาน
3. พอร์ต 10Gb RJ45	

พฤติกรรม LED

LED	สถานะ	คำอธิบาย
พลังงาน	สีเขียว	อุปกรณ์เปิดอยู่
	ปิด	อุปกรณ์เปิดอยู่
ไฟแสดงผล	ปิด	ไม่มีรูป
	สีแดงและกะพริบพร้อมพอร์ทัลูป	ลูปเกิดขึ้น
พอร์ทัล 10GbE SFP+	เขียว (ซ้าย)	การเชื่อมต่อทำงานที่ 10 Gbps, กะพริบ: เริ่มเชื่อมต่อ, ปิด: ไม่มีการเชื่อมต่อ, กะพริบพร้อมไฟแสดงผล: พอร์ทัลลูป
	สีแดงอำพัน (ขวา)	การเชื่อมต่อทำงานที่ 1 Gbps, กะพริบ: เริ่มเชื่อมต่อ, ปิด: ไม่มีการเชื่อมต่อ
พอร์ทัล 10GbE RJ45	เขียว (ซ้าย)	การเชื่อมต่อทำงานที่ 10 Gbps, กะพริบ: เริ่มเชื่อมต่อ, ปิด: ไม่มีการเชื่อมต่อ, กะพริบพร้อมไฟแสดงผล: พอร์ทัลลูป
	สีแดงอำพัน (ขวา)	การเชื่อมต่อทำงานที่ 5G/2.5G/1G/100M bps, กะพริบ: เริ่มเชื่อมต่อ, ปิด: ไม่มีการเชื่อมต่อ
พอร์ทัล 2.5GbE RJ45	เขียว (ซ้าย)	การเชื่อมต่อทำงานที่ 2.5 Gbps, กะพริบ: เริ่มเชื่อมต่อ, ปิด: ไม่มีการเชื่อมต่อ, กะพริบพร้อมไฟแสดงผล: พอร์ทัลลูป
	สีแดงอำพัน (ขวา)	การเชื่อมต่อทำงานที่ 1G/100M bps, กะพริบ: เริ่มเชื่อมต่อ, ปิด: ไม่มีการเชื่อมต่อ

QSW-2104-2S

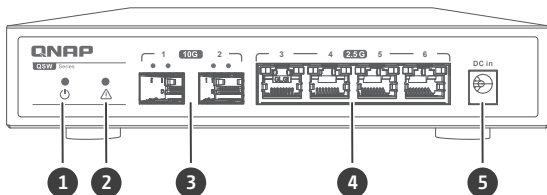

1. Dioda LED zasilania	4. Porty 2,5 GbE RJ45
2. Wskaźnik pętli	5. Wejście zasilania
3. Porty 10GbE SFP+	

QSW-2104-2T

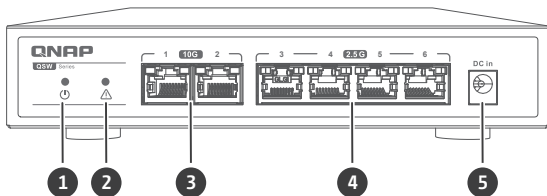

1. Dioda LED zasilania	4. Porty 2,5 GbE RJ45
2. Wskaźnik pętli	5. Wejście zasilania
3. Porty 10GbE RJ45	

Zachowanie diod LED

Dioda LED	Status	Opis
Zasilanie	Zielony	Urządzenie włączone
	Wył.	Urządzenie wyłączone
Wskaźnik pętli	Wył.	Brak pętli
	Czerwone i migające przy pętlach portów	Występuje pętla
Porty 10GbE SFP+	Zielona (lewa)	Łącze działa z szybkością 10 Gb/s, miga: podłączenie, wyłączone: brak połączenia, miga ze wskaźnikiem pętli: pętla portu
	Bursztynowa (prawa)	Łącze działa z szybkością 1 Gb/s, miga: podłączenie, wyłączone: brak połączenia.
Porty 10 GbE RJ45	Zielona (lewa)	Łącze działa z szybkością 10 Gb/s, miga: podłączenie, wyłączone: brak połączenia, miga ze wskaźnikiem pętli: pętla portu
	Bursztynowa (prawa)	Łącze działa z prędkością 5G/2,5G/1G/100 Mb/s, miga: podłączenie, wyłączone: brak połączenia.
Porty 2,5 GbE RJ45	Zielona (lewa)	Łącze działa z szybkością 2,5 Gb/s, miga: podłączenie, wyłączone: brak połączenia, miga ze wskaźnikiem pętli: pętla portu
	Bursztynowa (prawa)	Łącze działa z szybkością 1 Gb/s/100 Mb/s, miga: podłączenie, wyłączone: brak połączenia.

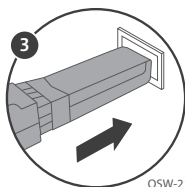
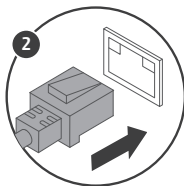
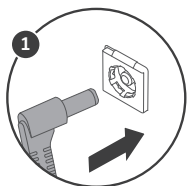

QSW-2104-2S

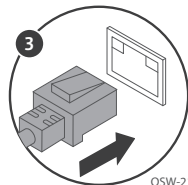

QSW-2104-2T

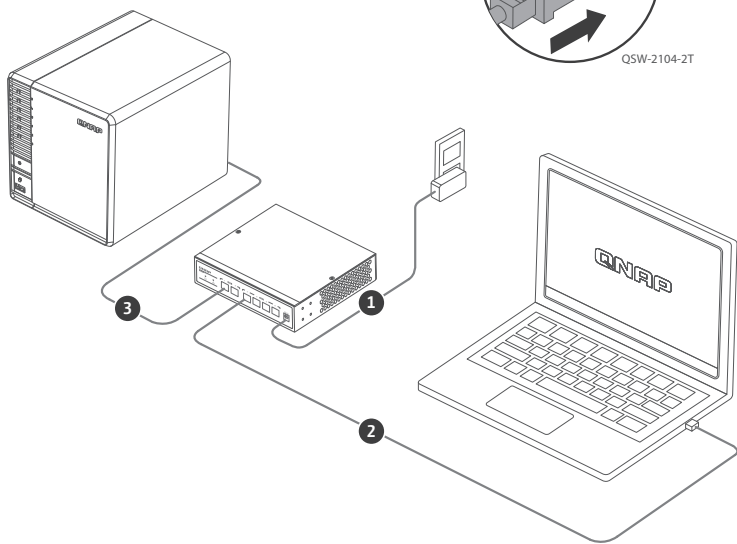



This device complies with Part 15 of the FCC Rules. Operation is subject to the following two conditions:

1. This device may not cause harmful interference.
2. This device must accept any interference received, including interference that may cause undesired operation.

FCC Class B Notice:

This equipment has been tested and found to comply with the limits for a Class B digital device, pursuant to Part 15 of the FCC Rules. These limits are designed to provide reasonable protection against harmful interference in a residential installation. This equipment generates, uses, and can radiate radio frequency energy and, if not installed and used in accordance with the instructions, may cause harmful interference to radio communications. However, there is no guarantee that interference will not occur in a particular installation. If this equipment does cause harmful interference to radio or television reception, which can be determined by turning the equipment off and on, the user is encouraged to try to correct the interference by one or more of the following measures:

- Reorient or relocate the receiving antenna.
- Increase the separation between the equipment and receiver.
- Connect the equipment into an outlet on a circuit different from that to which the receiver is connected.
- Consult the dealer or an experienced radio/television technician for help.

Modifications:

Any modifications made to this device that are not approved by QNAP Systems, Inc. may void the authority granted to the user by the FCC to operate this equipment.



This QNAP device complies with CE Compliance Class B.



According to the requirement of the WEEE legislation the following user information is provided to customers for all branded QNAP products subject to the WEEE directive.

This symbol on the product or on its packaging indicates that this product must not be disposed of with your other household waste. Instead, it is your responsibility to dispose of your waste equipment by handing it over to a designated collection point for the recycling of waste electrical and electronic equipment. The separate collection and recycling of your waste equipment at the time of disposal will help to conserve natural resources and ensure that it is recycled in a manner that protects human health and the environment. For more information about where you can drop off your waste equipment for recycling, please contact your local city office, your household waste disposal service or the shop where you purchased the product.



D33B77
RoHS

更多關於安全、法規・與環境法令遵循相關的資訊・請參閱以下網址 www.qnap.com/regulatory/・



Office in EU:
QNAP GmbH,
Linsellesstrasse 109
47877 Willich, Germany

Office in UK:
QNAP Ltd,
2 Drakes Meadow, Swindon SN3 3LL
United Kingdom

声明 此为 A 级产品・在生活环境中・该产品可能会造成无线电干扰。在这种情况下・可能需要用户对其干扰采取切实可行的措施。仅适用于海拔 2000m 以下地区安全使用。



※付属の電源コードは当該製品専用です。他の機器に使用しないでください。

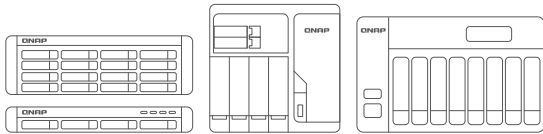

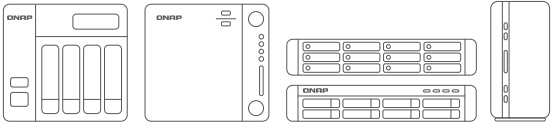



install.qnap.com



service.qnap.com



download.qnap.com

QNAP