

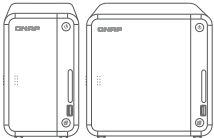

NAS

Quick Installation Guide

快速安裝手冊 빠른 설치 설명서 Guía de Instalación Rápida
クイックインストールガイド Hızlı Kurulum Kılavuzu
คู่มือการติดตั้งแบบเร็ว Gyors telepítési útmutató
Instrukcja szybkiej instalacji Průvodce rychlou instalací
Kurzinstructionsanleitung 快速安裝指南
Guida di installazione rapida Pika-asennusopas
Краткое руководство по установке
Snabbinstallationsguide
Guia de Instalação Rápida
Hurtiginstallasjonsveileder
Hurtig installationsvejledning
Pika-asennusopas
Snelle Installatiegids

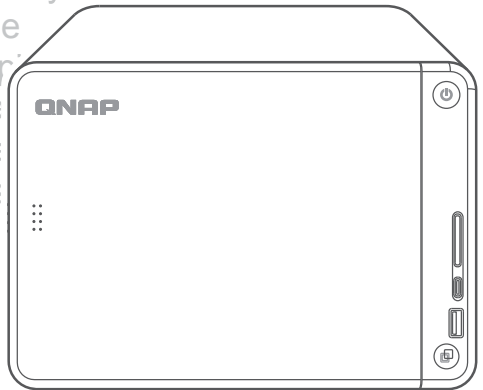

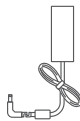
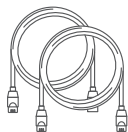
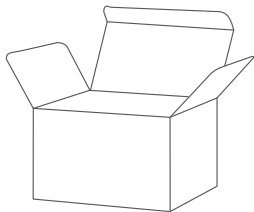



HDD / SSD

<http://www.qnap.com/compatibility>

- All the drive data will be cleared upon SSD / HDD initialization – – – – – en
- Alle Laufwerksdaten werden bei SSD/HDD-Initialisierung gelöscht – – – – – de
- Toutes les données présentes sur les disques seront effacées lors de l'initialisation des SSD/HDD – – – – – fr
- Tutti i dati presenti verranno cancellati durante l'inizializzazione degli SSD / HDD – – – – – it
- Todos los datos del disco serán borrados con la inicialización del SSD / HDD – – – – – es
- Alle gegevens worden gewist tijdens de initialisatie van de SSD / HDD's – – – – – nl
- All data kommer att raderas när SSD / HDD initieras – – – – – sv
- SSD / HDD alustaminen poistaa kaikki tiedostot – – – – – fi
- Alle data på drevet vil blive ryddet efter initialisering af SSD / HDD – – – – – da
- All data vil bli slettet når SSD / HDD er initialisert – – – – – no
- Todos os dados do SSD / HDD serão apagados com a inicialização do SSD / HDD – – – – – pt
- После инициализации SSD/HDD все данные на нем будут удалены – – – – – ru
- 硬碟初始化時，所有資料皆會被清除 – – – – – zh
- 所有 SSD / HDD 上的数据都将会被清除 – – – – – cn
- SSD/HDD を初期化すると、すべてのデータが消去されます – – – – – ja
- SSD / HDD 를 초기화 시키면 드라이브의 모든 데이터가 손실됩니다 – – – – – ko
- ข้อมูลในไดรฟ์จะถูกลบออก เมื่อมีการตั้งค่าเริ่มต้น – – – – – th
- Kurulum başladığında SSD / HDD disk üzerinde ki tüm veri silinecektir – – – – – tr
- Minden korábbi adat törlődik az SSD / HDD-ről az első rendszereződés során – – – – – hu
- Všechna data na SSD / HDD budou smazána v důsledku inicializace – – – – – cs
- Podczas instalacji wszystkie dane na dyskach SSD / HDD zostaną usunięte – – – – – pl
- يتم مسح كل بيانات محرك الأقراص عند تهيئة HDD(قرص الحالة الصلبة) /SSD(محرك الأقراص الصلبة) – – – – – ar

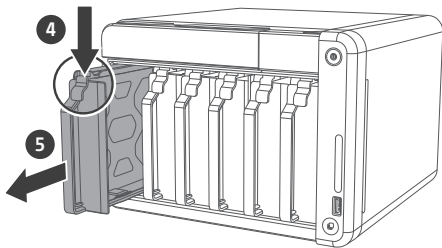
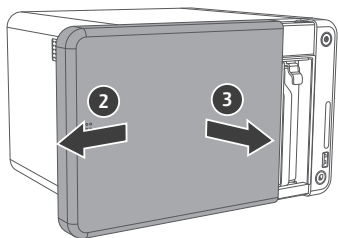
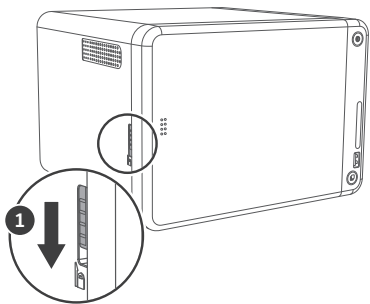

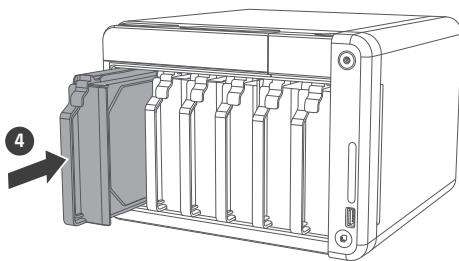
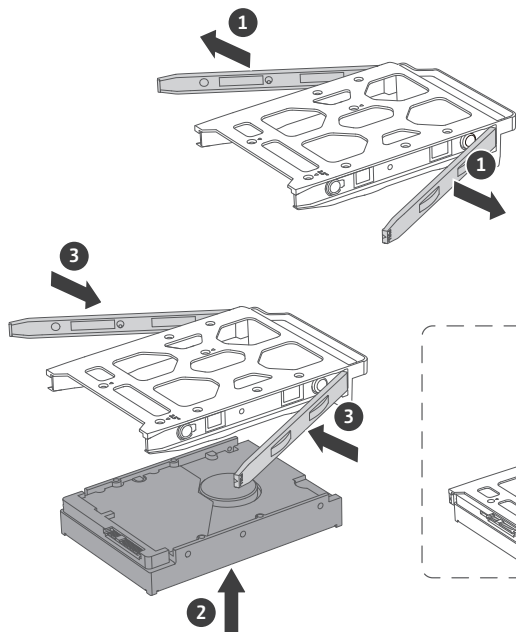

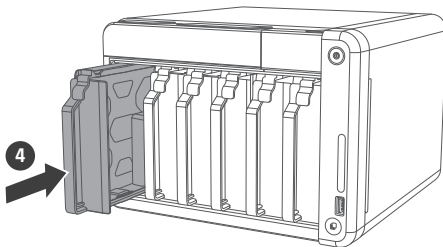
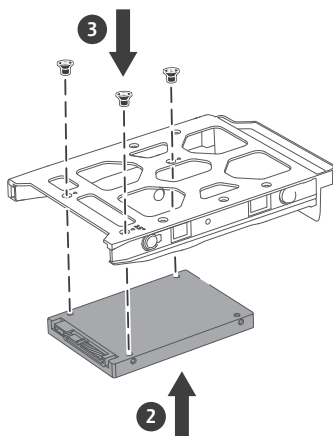
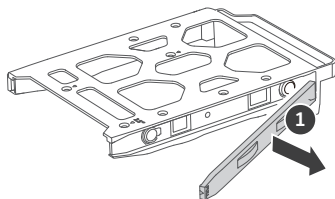

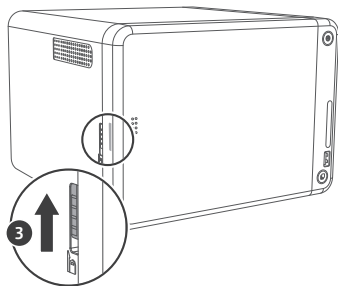
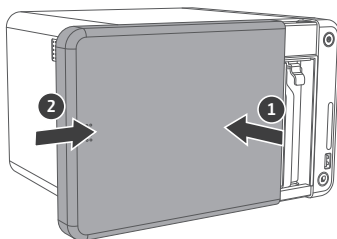

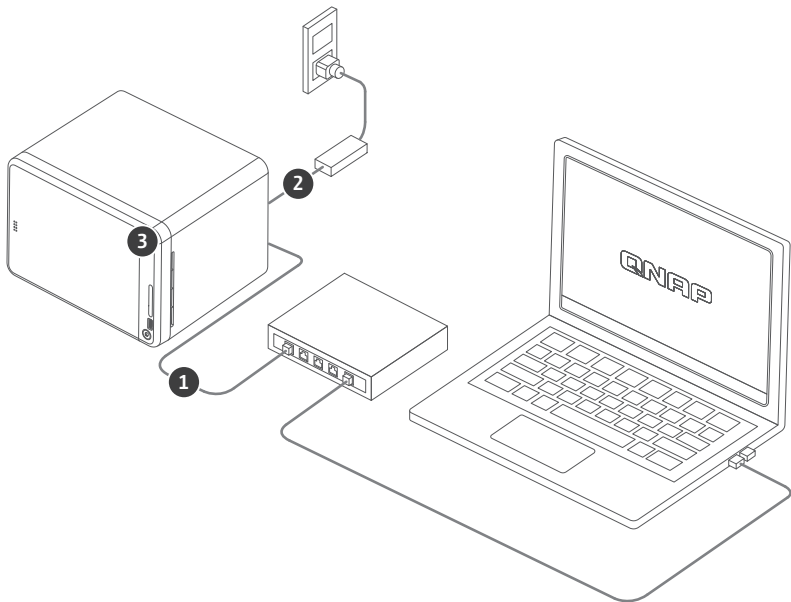
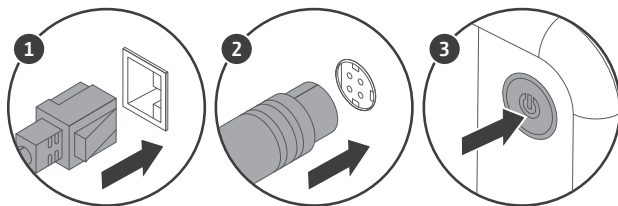



Qfinder Pro



Windows



Mac



Linux

<http://www.qnap.com/qfinderpro>

a



b

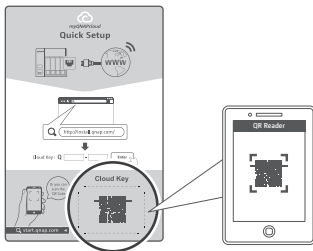

c



To locate the NAS, you can: a) Install the Qfinder Pro utility, b) Scan the QR code, or c) Go to the myQNAPcloud website and manually enter the Cloud Key ----- en

So können Sie das NAS lokalisieren: a) Dienstprogramm Qfinder Pro installieren, b) QR-Code scannen, oder c) myQNAPcloud-Webseite aufrufen und Cloud-Schlüssel manuell eingeben ----- de

Pour localiser le NAS, vous pouvez : a) Installer l'utilitaire Qfinder Pro, b) Scanner le QR code, ou c) Vous rendre sur le site web de myQNAPcloud et entrer manuellement la clé cloud ----- fr

Per localizzare il NAS, è possibile: a) Installare l'utilità Qfinder Pro, b) Scansionare il codice QR, oppure c) Andare sul sito Web myQNAPcloud e inserire manualmente la chiave cloud ----- it

Para localizar el NAS, usted puede: a) Instalar la utilidad Qfinder Pro, b) Escanear el código QR, o c) Ir a la página web myQNAPcloud e introducir manualmente la Clave de la Nube (Cloud Key) ----- es

Om de NAS te vinden kunt u: a) het programma Qfinder Pro installeren, b) de QR-code scannen, of c) naar de website van myQNAPcloud gaan en handmatig de Cloudsleutel invoeren ----- nl

För att hitta NAS-enheten kan du: a) Installera hjälpprogrammet Qfinder Pro, b) Skanna QR-koden eller c) Gå till myQNAPcloud-webbplatsen och skriva in molnnyckeln manuellt ----- sv

NAS-palvelimen paikallistamiseksi voit: a) Asentaa Qfinder Pro -apuohjelman b) Skannata QR-koodin, c) Siirtyä myQNAPcloud-web-sivustolle ja syöttää manuaalisesti Pilviavaimen ----- fi

For at finde NAS'en kan du: a) Installere Qfinder Pro-programmet, b) Scanne QR-koden eller c) ge til myQNAPcloud-webstedet og manuelt indtaste Cloud-nøglen ----- da

Slik finner du NAS-en: a) installer Qfinder Pro-verktøyet, b) Skann QR-koden, eller c) Gå til nettstedet til myQNAPcloud og angi nettskynøkkelen manuelt ----- no

Para localizar o NAS, você pode: a) Instalar o utilitário Qfinder Pro b) Escanear o QR Code, ou c) Visitar o site myQNAPcloud e inserir a Chave de Nuvem ----- pt

Найти накопитель в сети можно следующими способами: a) установить утилиту Qfinder Pro, b) отсканировать QR-код перейти, c) на веб-сайт myQNAPcloud и вручную ввести облачный ключ ----- ru

欲連接您的 NAS，您可以：a) 安裝 Qfinder Pro · b) 掃描 QR Code · 或 c) 前往 myQNAPcloud 網站輸入 Cloud Key ----- zh

要查找 NAS，您可以：a) 安裝 Qfinder Pro 组件 · b) 扫描二维码 · 或者 c) 到 myQNAPcloud 网站 (https://install.qnap.com.cn) 手动输入云钥 ----- cn

NAS を検索する場合、下記いずれの方法を選択できます。 a) Qfinder Pro ユーティリティを導入する、b) QR コードをスキャンする、c) QNAPcloud Web サイトに移動してクラウドキーを入力する ----- ja

NAS 를 찾으려면 , a) Qfinder Pro 유틸리티를 설치하고 , b) QR 코드를 스캔하거나 , 또는 c) 클라우드 키를 입력하여 수동으로 myQNAPcloud 웹사이트로 이동하십시오 ----- ko

เมื่อต้องการค้นหา NAS คุณสามารถ a) ติดตั้งโปรแกรมอรรถประโยชน์ Qfinder Pro b) สแกนรหัส QR หรือ c) ไปที่เว็บไซต์ myQNAPcloud และป้อนคีย์ระบบคลาวด์ด้วยตัวเอง ----- th

NAS'ı konumlandırmak için yapabileceğiniz: a) Qfinder Pro yardımcı yazılımını kurun, b) QR kodunu tarayın veya c) myQNAPcloud web sitesine gidip Bulut Anahtarını elle girin ----- tr

A NAS megkereséséhez a következőket teheti: a) Telepítse a Qfinder Pro segédprogramot. b) Olvassa le a QR-kódot. c) Látogasson el a myQNAPcloud webhelyére, és adja meg manuálisan a Felhő kódját ----- hu

Vyhledat NAS v síti můžete: a) instalací nástroje Qfinder Pro, b) načtením kódu QR, nebo c) navštívením webových stránek myQNAPcloud a manuálním zadáním Cloud Key ----- cs

Aby zlokalizować serwer NAS, możesz: a) zainstalować narzędzie Qfinder Pro, b) zeskanować kod QR, lub c) przejść do witryny myQNAPcloud i ręcznie wprowadzić klucz konfiguracji chmury ----- pl

QFinder Pro للبحث عن جهاز NAS يمكنك من خلال : 1- اعداد واستخدام برنامج ----- ar

2- عمل مسح للبرنامج QR Code أو 3- الذهاب الى موقع myQNAPCloud وبشكل يدوي ادخال Cloud Key

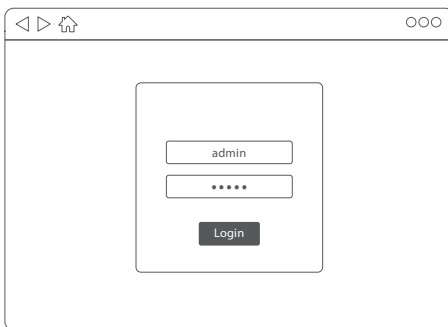

Log into the admin account using your specified password or use the default password (admin) – – – – –	en
Mit dem benutzerdefinierten oder Standardkennwort (admin) am Administratorkonto anmelden – – – – –	de
Connectez-vous au compte admin à l'aide du mot de passe que vous avez spécifié ou du mot de passe par défaut (admin) – – – – –	fr
Accedere all'account admin utilizzando la password specificata o la password predefinita (admin) – – – – –	it
Iniciar sesión como administrador usando la contraseña especificada o use la contraseña predeterminada (admin) – – – – –	es
Gebruik uw opgegeven wachtwoord of gebruik het standaard wachtwoord (admin) om in te loggen op het beheerdersaccount – – – – –	nl
Logga in till administratörskontot med ditt angivna lösenord eller använd standardlösenordet (admin) – – – – –	sv
Kirjaudu sisään järjestelmänvalvojaltille käyttämällä määritettyä salasanaa tai käytä oletussalasanaa (admin) – – – – –	fi
Log ind på adminkontoen med den specificerede adgangskode eller brug standardadgangskoden (admin) – – – – –	da
Logg på administratorkontoen med det angitte passordet, eller bruk standardpassordet (admin) – – – – –	no
Fazer login na conta de administrador usando sua senha especificada ou usar a senha padrão (admin) – – – – –	pt
Войдите в учетную запись администратора с заданным паролем или используйте пароль по умолчанию (admin)	ru
使用自訂密碼或預設密碼 (admin) 登入 admin 帳戶 – – – – –	zh
使用您设定的或预设的密码登入 admin 帐户 – – – – –	cn
設定したのパスワードで管理者アカウントにログインし、初期パスワード (admin) を使用しません – – – – –	ja
관리자 계정으로 로그인합니다. 지정된 비밀번호를 사용하거나 기본 비밀번호 (admin) 를 사용하면 됩니다 – – – – –	ko
ສ້ອກອິນເຂົ້າບັງຄັບຜູ້ຄູແລະຈະບໍ່ໂດຍໃຊ້ກຳລັງສຳມາດພາະຂອງທ່ານ ຫຼືໃຊ້ກຳລັງສຳມາດຄຳເຮັມຕົ້ນ (ຜູ້ຄູແລ) – – – – –	th
Belirlediğiniz şifreyi veya varsayılan şifreyi (admin) kullanarak yönetici hesabında oturum açın – – – – –	tr
Jelentkezzen be rendszergazdaként a megadott jelszóval vagy használja az alapértelmezett (admin) jelszót – – – – –	hu
Přihlaste se k účtu administrátora pomocí svého specifikovaného hesla nebo použijte implicitní heslo (admin) – – – – –	cs
Zaloguj się na konto administratora przy użyciu wybranego przez siebie hasła lub hasła domyślnego (admin) – – – – –	pl
سجل الدخول إلى حساب المسؤول مستخدمًا كلمة المرور الخاصة بك أو كلمة المرور الافتراضية وهي (admin) – – – – –	ar

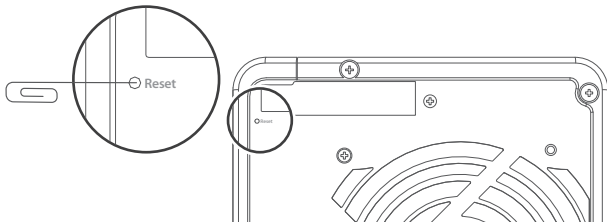

- To revert to the default password, use a pin to press the Reset button for three seconds or until you hear a short beep – en
- Zum Zurücksetzen auf das Standardkennwort müssen Sie die Reset-Taste drei Sekunden lang oder bis zur Ausgabe eines kurzen Signaltons mit einem schmalen spitzen Gegenstand drücken – de
- Pour revenir au mot de passe par défaut, utilisez une pointe pour appuyer sur le bouton Réinitialiser pendant trois secondes ou jusqu'à ce que vous entendiez un bip court – fr
- Per tornare alla password predefinita, usare uno spillo per premere il tasto Reset per tre secondi o fino a che non si sente il segnale acustico – it
- Para restaurar la contraseña predeterminada, utilice un objeto puntiagudo para pulsar el botón Restablecer durante tres segundos o hasta que escuche un pitido corto – es
- Om terug te keren naar het oude wachtwoord, gebruik u een pennetje om de Reset-knop drie seconden in te drukken of tot u een korte pieptoon hoort – nl
- För att återställa standardlösenordet , använd en nål för att trycka in återställningsknappen i tre sekunder eller tills du hör ett kort pip – sv
- Palataksesi oletussalasanaan, paina neulalla nollauspainiketta kolme sekuntia, kunnes kuulet lyhyen merkkiäänen – fi
- For at gendanne til standardgangskoden, skal du bruge en clips til at trykke på nulstillingsknappen i tre sekunder eller indtil du hører et kort bip – da
- For å gå tilbake til standardpassordet kan du bruke en nål til å trykke inne Reset-knappen i tre sekunder eller til du hører et kort pip – no
- Para reverter para a senha padrão, utilize um pino para pressionar o botão de Reset por três segundos ou até que você ouça um bipe curto – pt
- Чтобы восстановить пароль по умолчанию, булавкой держите нажатой кнопку сброса три секунды или до подачи короткого звукового сигнала – ru
- 恢復預設密碼的方法：用迴紋針尖壓著「重設」鈕三秒鐘，直到聽見短促嗶聲為止 – zh
- 欲恢复到默认密码，请用针状物抵按 Reset 键 3 秒或直至听见短促“哔”声 – cn
- 既定のパスワードに戻すには、ピンを利用してリセットボタンを 3 秒間（あるいは、ピー音が短く鳴るまで）押します – ja
- 기본 비밀번호로 되돌리려면 Reset(리셋) 버튼을 핀으로 3 초간 또는 짧은 경고음이 울릴 때까지 누르고 있으면 됩니다 – ko
- หากต้องการกลับไปใช้รหัสผ่านค่าเริ่มต้น ให้ใช้เข็มกดปุ่มรีเซ็ตเป็นเวลา 3 วินาที หรือจนกว่าคุณจะได้ยินเสียงสัญญาณเตือนสั้น ๆ – th
- Varsayılan şifreye dönmek amacıyla, Sıfırla düğmesine üç saniye boyunca veya kısa bir sesli uyan duyana kadar basmak için bir iğne kullanın – tr
- Az alapértelmezett jelszó visszaállításához nyomja meg a Reset gombot a túvel három másodpercig vagy amíg egy rövid hangjelzést nem hall – hu
- Chcete-li obnovit původní heslo, pomocí tenkého a špičatého předmětu stiskněte a podržte resetovací tlačítko tři sekundy nebo do zaznění krátkého pípnutí – cs
- Aby przywrócić hasło domyślne, należy za pomocą szpilki wcisnąć przycisk Reset i przytrzymać go przez trzy sekundy, aż do usłyszenia krótkiego sygnału – pl
- لاستعادة كلمة المرور الافتراضية: استخدم دبوسًا للضغط على زر Reset (إعادة الضبط) لمدة ثلاث ثوانٍ أو حتى تسمع صوت صفير قصير – ar



This device complies with Part 15 of the FCC Rules. Operation is subject to the following two conditions:

1. This device may not cause harmful interference.
2. This device must accept any interference received, including interference that may cause undesired operation.

FCC Class B Notice:

This equipment has been tested and found to comply with the limits for a Class B digital device, pursuant to Part 15 of the FCC Rules. These limits are designed to provide reasonable protection against harmful interference in a residential installation. This equipment generates, uses, and can radiate radio frequency energy and, if not installed and used in accordance with the instructions, may cause harmful interference to radio communications. However, there is no guarantee that interference will not occur in a particular installation. If this equipment does cause harmful interference to radio or television reception, which can be determined by turning the equipment off and on, the user is encouraged to try to correct the interference by one or more of the following measures:

- Reorient or relocate the receiving antenna.
- Increase the separation between the equipment and receiver.
- Connect the equipment into an outlet on a circuit different from that to which the receiver is connected.
- Consult the dealer or an experienced radio/television technician for help.

Modifications:

Any modifications made to this device that are not approved by QNAP Systems, Inc. may void the authority granted to the user by the FCC to operate this equipment.



This QNAP NAS complies with CE Compliance Class B.



According to the requirement of the WEEE legislation the following user information is provided to customers for all branded QNAP products subject to the WEEE directive.

This symbol on the product or on its packaging indicates that this product must not be disposed of with your other household waste. Instead, it is your responsibility to dispose of your waste equipment by handing it over to a designated collection point for the recycling of waste electrical and electronic equipment. The separate collection and recycling of your waste equipment at the time of disposal will help to conserve natural resources and ensure that it is recycled in a manner that protects human health and the environment. For more information about where you can drop off your waste equipment for recycling, please contact your local city office, your household waste disposal service or the shop where you purchased the product.



更多關於安全、法規、與環境法令遵循相關的資訊，請參閱以下網址 www.qnap.com/regulatory/

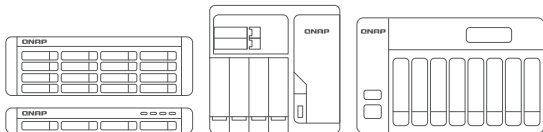

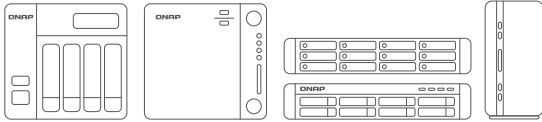



start.qnap.com



helpdesk.qnap.com



docs.qnap.com



www.qnap.com/download

QNAP

Printed in Taiwan
P/N: 51000-024376-RS