



NAS

Quick Installation Guide

快速安裝手冊 빠른 설치 설명서 Snelle Installatiegids

クイックインストールガイド Hızlı Kurulum Kılavuzu

คู่มือการติดตั้งแบบเร็ว Gyors telepítési útmutató

Instrukcja szybkiej instalacji 快速安裝指南

Kurzinstallationsanleitung Guía de Instalación Rápida

Guida di installazione rapida Pika-asennusopas

Краткое руководство по установке

Snabbinstallationsguide Guia de Instalação Rápida

Hurtiginstallasjonsveiledning Průvodce rychlou instalací

Hurtig installation

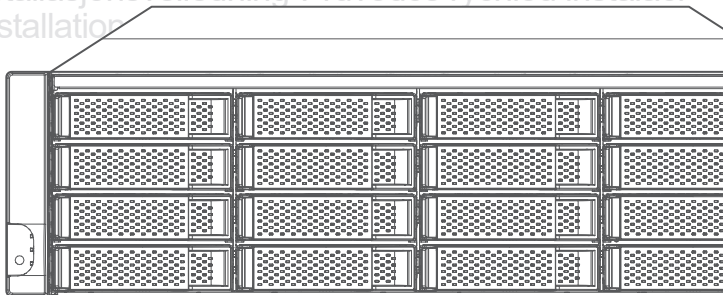

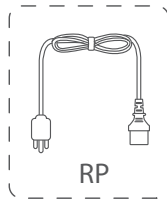
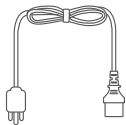
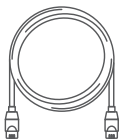
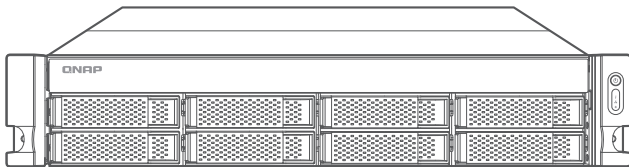

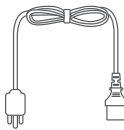
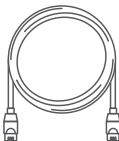
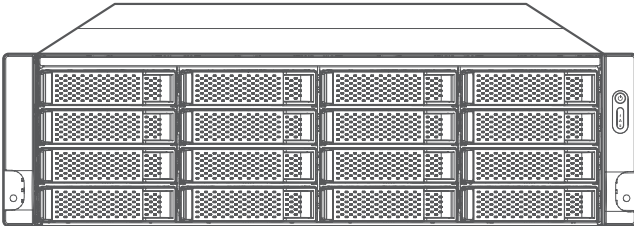
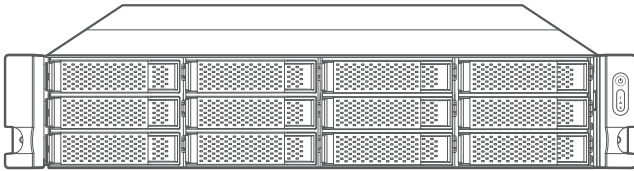

x2



SSD/HDD

<https://www.qnap.com/compatibility>

All the drive data will be cleared upon SSD / HDD initialization	en
Alle Laufwerksdaten werden bei SSD/HDD-Initialisierung gelöscht	de
Toutes les données présentes sur les disques seront effacées lors de l'initialisation des SSD/HDD	fr
Tutti i dati presenti verranno cancellati durante l'inizializzazione degli SSD / HDD	it
Todos los datos del disco serán borrados con la inicialización del SSD / HDD	es
Alle gegevens worden gewist tijdens de initialisatie van de SSD / HDD's	nl
All data kommer att raderas när SSD / HDD initieras	sv
SSD / HDD alustaminen poistaa kaikki tiedostot	fi
Alle data på drevet vil blive ryddet efter initialisering af SSD / HDD	da
All data vil bli slettet når SSD / HDD er initialisert	no
Todos os dados do SSD / HDD serão apagados com a inicialização do SSD / HDD	pt
После инициализации SSD/HDD все данные на нем будут удалены	ru
硬碟初始化時·所有資料皆會被清除	tw
所有 SSD / HDD 上的数据都将会被清除	cn
SSD/HDD を初期化すると、すべてのデータが消去されます	ja
SSD / HDD 를 초기화 시키면 드라이브의 모든 데이터가 손실됩니다	ko
ข้อมูลในไดรฟ์จะถูกลบออก เมื่อมีการตั้งค่าเริ่มต้น	th
Kurulum başladığında SSD / HDD disk üzerinde ki tüm veri silinecektir	tr
Minden korábbi adat törlődik az SSD / HDD-ről az első rendszerezítäs során	hu
Všechna data na SSD / HDD budou smazána v úsledku inicializace	cs
Podczas instalacji wszystkie dane na dyskach SSD / HDD zostaną usunięte	pl
يتم مسح كل بيانات محرك الأقراص عند تهيئة HDD(قرص الحالة الصلبة) / SSD(محرك الأقراص الصلبة)	ar

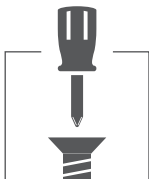

- Tighten the screws to prevent the tray from getting stuck to the chassis. ----- en
- Ziehen Sie die Schrauben an, um zu verhindern, dass der Einschub am Gehäuse stecken bleibt. ----- de
- Serrez les vis pour éviter que le plateau ne reste collé au châssis. ----- fr
- Serrare le viti per evitare che il vano si blocchi nello chassis. ----- it
- Apriete los tornillos para evitar que la bandeja quede atascada en el chasis. ----- es
- Draai de schroeven vast om te voorkomen dat de lade bekneld raakt in het frame. ----- nl
- Dra åt skruvarna för att förhindra att facket fastnar i chassina. ----- sv
- Kiristä ruuvit, jotta alusta ei juutu runkoon. ----- fi
- Spænd skruerne for at forhindre bakken i at sidde fast i kabinettet. ----- da
- Trekk til skruene for å unngå at skuffen setter seg fast i kabinettet. ----- no
- Aperte os parafusos para evitar que a bandeja fique travada no chassi. ----- pt
- Затяните винты, чтобы лоток не сошел с шасси. ----- ru
- 鎖緊螺絲以防止托盤卡在機殼裡。 ----- tw
- 拧紧螺丝，以免托盘卡在机箱上。 ----- cn
- トレイがシャーシに引っかからないようにネジを締めます。 ----- ja
- 트레이가 새시에 걸리지 않도록 나사를 조여 주십시오. ----- ko
- ขันสกรูให้แน่น เพื่อป้องกันไม่ให้ถาดไปติดกับแชนซี ----- th
- Tepsinin çerçeveye sıkışmasını önlemek için vidaları sıkın. ----- tr
- Húzza meg a csavarokat, hogy a tálca ne akadjon el a házban. ----- hu
- Abyste zabránili zaklinění příhrádky k šasi, utáhněte šrouby. ----- cs
- Dokładnie dokręć wkręty, aby kieszeń nie zaklinowała się w obudowie. ----- pl
- أحكام ربط المسامير لمنع العلبه من الالتصاق بالهيكل ----- ar

3.5-inch HDD

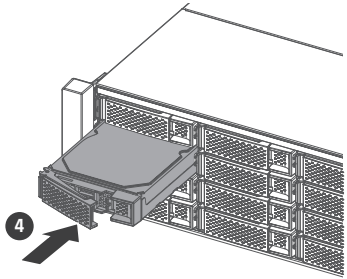
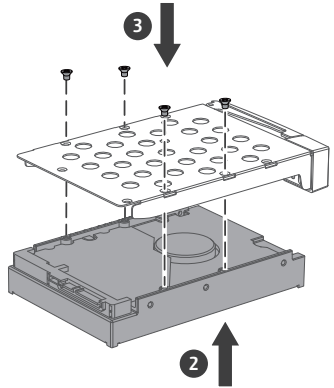
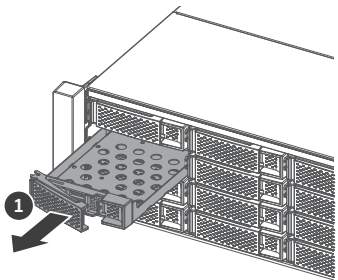

2.5-inch HDD / SSD

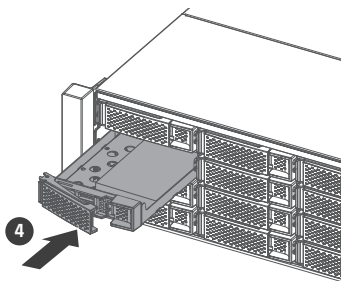
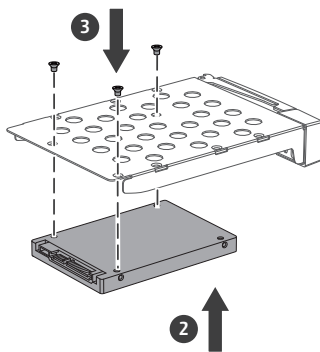
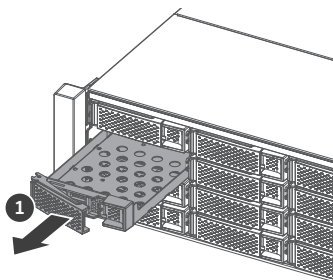

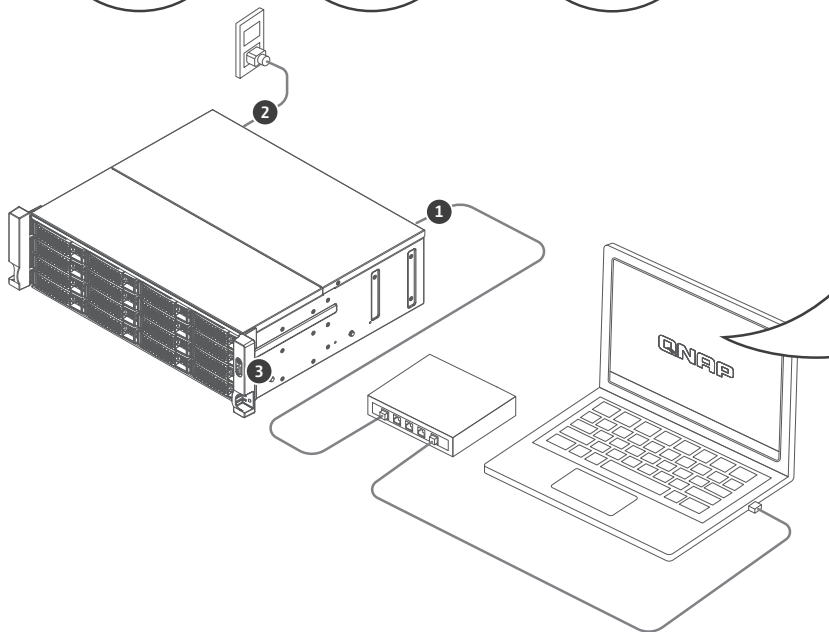
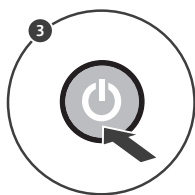
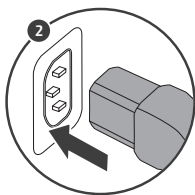
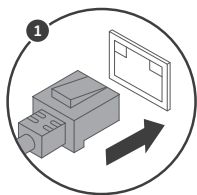

 Qfinder Pro



<http://www.qnap.com/qfinderpro>

a



b

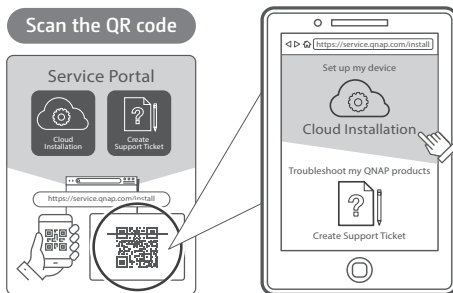

Reset





Download Center
www.qnap.com/download

- Visit Download Center for our full guides and utilities. ----- en
- Unsere vollständigen Handbücher und Dienstprogramme finden Sie im Download Center. ----- de
- Visitez le Centre de téléchargement pour accéder à nos guides et utilitaires complets. ----- fr
- Per le guide e le utilità complete, visitare il Centro download. ----- it
- Visite el Centro de descargas para ver todas nuestras guías y utilidades. ----- es
- Bezoek het downloadcentrum voor onze uitgebreide gidsen en hulpprogramma's. ----- nl
- Besök Nedladdningscenter för våra fullständiga guider och verktyg. ----- sv
- Katso täydelliset oppaat ja apuohjelmat latauskeskuksestamme. ----- fi
- Besøg Downloadcenter for at se alle vores vejledninger og hjælpværktøjer. ----- da
- Gå til Nedlastingscenter for fullstendige veiledninger og verktøy. ----- no
- Visite a Central de Download para acessar nossos guias e utilitários completos. ----- pt
- Чтобы ознакомиться с полным набором руководств и служебных программ, посетите Центр загрузки. ----- ru
- 請前往下載中心取得完整指南和應用工具。 ----- tw
- 有关完整指南和实用工具·请访问“下载中心”。 ----- cn
- 完全なガイドとユーティリティについては、ダウンロードセンターをご覧ください。 ----- ja
- 다운로드 센터에서 전체 지침 및 유틸리티를 확인하십시오. ----- ko
- กรุณาเข้าสู่ศูนย์การดาวน์โหลดเพื่อดูคู่มือฉบับสมบูรณ์และโปรแกรมอรรถประโยชน์ต่างๆ ----- th
- Tam klavuzumuz ve yardımcı hizmetlerimiz için İndirme Merkezi'ni ziyaret edin. ----- tr
- A teljes útmutatók és segédprogramok megtekintéséhez keresse fel a Letöltési központot. ----- hu
- Kompletního průvodce a nástroje najdete na webu Centrum stahování. ----- cs
- Odowiedź Centrum pobierania, aby uzyskać kompletne przewodniki i narzędzia. ----- pl
- المساعدة الكاملة للحصول على الأدلة والأدوات تفضل بزيارة مركز التنزيل ----- ar



This device complies with Part 15 of the FCC Rules. Operation is subject to the following two conditions:

1. This device may not cause harmful interference.
2. This device must accept any interference received, including interference that may cause undesired operation.

FCC Class A Notice:

This equipment has been tested and found to comply with the limits for a Class A digital device, pursuant to Part 15 of the FCC Rules. These limits are designed to provide reasonable protection against harmful interference when the equipment is operated in a commercial environment. This equipment generates, uses, and can radiate radio frequency energy, and if not installed and used in accordance with the instruction manual, may cause harmful interference to radio communications. Operation of this equipment in a residential area is likely to cause harmful interference, in which case the user will be required to correct the interference at his own expense.

Modifications: Any modifications made to this device that are not approved by QNAP Systems, Inc. may void the authority granted to the user by the FCC to operate this equipment.



This device complies with CE compliance Class A.



According to the requirement of the WEEE legislation the following user information is provided to customers for all branded QNAP Electronics products subject to the WEEE directive.

This symbol on the product or on its packaging indicates that this product must not be disposed of with your other household waste. Instead, it is your responsibility to dispose of your waste equipment by handing it over to a designated collection point for the recycling of waste electrical and electronic equipment. The separate collection and recycling of your waste equipment at the time of disposal will help to conserve natural resources and ensure that it is recycled in a manner that protects human health and the environment. For more information about where you can drop off your waste equipment for recycling, please contact your local city office, your household waste disposal service or the shop where you purchased the product.



更多關於安全、法規・與環境法令遵循相關的資訊・請參閱以下網址 www.qnap.com/regulatory/。



※ 付属の電源コードは当該製品専用です。他の機器に使用しないでください。



install.qnap.com



service.qnap.com



docs.qnap.com

QNAP

Printed in Taiwan
P/N: 51000-024837-RS