



**QNAP**

# **QSW-M2106**

**QSW-M2106R**

**用户指南**

# 内容

<b>1. 产品概述</b>	
关于 QSW-M2106R.....	3
硬件规格.....	3
包装内容.....	4
组件.....	4
前面板.....	4
前面板 LED.....	5
安全信息.....	5
<b>2. 安装和访问</b>	
安装要求.....	7
设置交换机.....	7
安装橡胶垫脚.....	7
安装手柄.....	9
将交换机连接到计算机或网络.....	10
将交换机连接到计算机.....	10
将交换机连接到网络.....	11
交换机访问.....	12
使用浏览器访问交换机.....	12
使用 Qfinder Pro 访问交换机.....	13
<b>3. 基本操作</b>	
LED.....	14
重置按钮.....	15
<b>4. QSS</b>	
关于 QSS.....	16
开始使用.....	16
网络管理.....	16
配置端口设置.....	16
添加 VLAN.....	17
添加链路聚合组 (LAG).....	17
管理快速生成树协议 (RSTP) 设置.....	18
配置 LLDP 设置.....	19
添加静态 MAC 地址.....	19
配置 IGMP 侦听.....	20
配置 QoS 设置.....	20
管理访问控制列表 (ACL) 条目.....	21
删除网络设置.....	22
监控网络设置.....	23
系统管理.....	24
系统设置.....	24
固件更新.....	28
<b>5. 支持和其他资源</b>	
<b>6. 术语表</b>	
myQNAPcloud.....	33
Qfinder Pro.....	33
QSS.....	33

QuNetSwitch.....	33
------------------	----

## 7. 声明

有限保修.....	34
免责声明.....	34
GNU Public License.....	34
CE 声明.....	42
FCC 声明.....	42
VCCI 公告.....	42
BSMI 公告.....	43
SJ/T 11364-2006.....	43
欧盟指令 2002/96/EC 废弃电子电气设备 (WEEE).....	44
EU RoHS 声明.....	44
激光合规声明.....	44
UKCA 声明.....	44

# 1. 产品概述

本章提供有关 QNAP 设备的基本信息。

## 关于 QSW-M2106R

QSW-M2106R 是一个多千兆位以太网交换机，提供第 2 层网络管理功能。该交换机配有六个 2.5 GbE RJ45 端口、两个 10 GbE RJ45 端口和两个 10 GbE SFP+ combo 端口，可提高网络可扩展性和运行效率。可使用 RJ45 控制台端口访问交换机，以实现高效的设备管理和交换机操作。

## 硬件规格



### 警告

如果您的 QNAP 产品有硬件方面的缺陷，请将产品退回 QNAP 或 QNAP 授权的服务中心进行维修或更换。您本人或未经授权的第三方对产品进行的任何维修或维护流程均会使保修失效。

对于因未经授权进行的修改和安装不受支持的第三方应用程序而造成的任何损坏或数据丢失，QNAP 概不负责。

有关详细信息，请参见 [QNAP 保修条款和条件](#)。



### 提示

型号规格如有更改，恕不另行通知。要查看最新规格，请转到 <https://www.qnap.com>。

订购部件号	CPU	内存
QSW-M2106R-2S2T	Marvell® Prestera® 98DX2528	1 GB

组件	QSW-M2106R-2S2T
处理器	
CPU	Marvell® Prestera® 98DX2528
频率	双核
架构	ARM 32 位
芯片组	Marvell® Prestera® 98DX2528
网络接口	<ul style="list-style-type: none"> <li>• 6 x 100M/1G/2.5G RJ45 端口</li> <li>• 2 x 100M/1G/2.5G/5G/10G GbE RJ45 端口</li> <li>• 2 x 1G/10G SFP+ combo 端口</li> </ul>
管理接口	1 x RJ45 控制台端口
总功耗	40W
界面	
按钮	交换机重置
LED	
系统	状态
端口	<ul style="list-style-type: none"> <li>• 速度</li> <li>• 活动</li> </ul>
尺寸	
外形规格	紧凑

组件	QSW-M2106R-2S2T
尺寸 (高 x 宽 x 深)	43.3 x 207 x 248.8 mm (1.70 x 8.14 x 9.79 英寸)
净重	1.55kg (3.41 磅)
其他	
电源单元	100-240V, 50/60 Hz
工作温度	0°C 至 40°C (32 至 104°F)
相对湿度	<ul style="list-style-type: none"> <li>无冷凝相对湿度: 5% 至 95%</li> <li>湿球温度: 27°C (80.6°F)</li> </ul>

## 包装内容

项目	数量
QSW-M2106R	1
电源线	1
导轨支架	2
导轨支架螺丝	6
橡胶垫脚	4
快速安装指南 (QIG)	1

## 组件

### 前面板

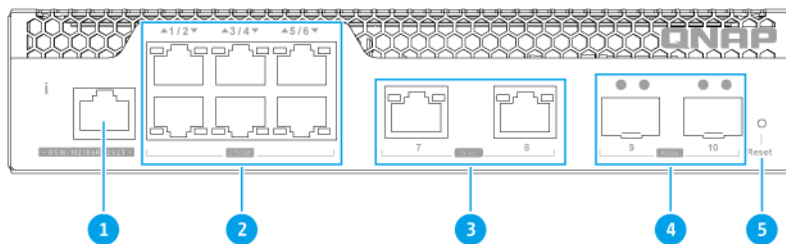

编号	组件	编号	组件
1	RJ45 控制台端口	4	10 GbE SFP+ 端口
2	2.5 GbE RJ45 端口	5	交换机重置按钮
3	10 GbE RJ45 端口	-	-

## 前面板 LED

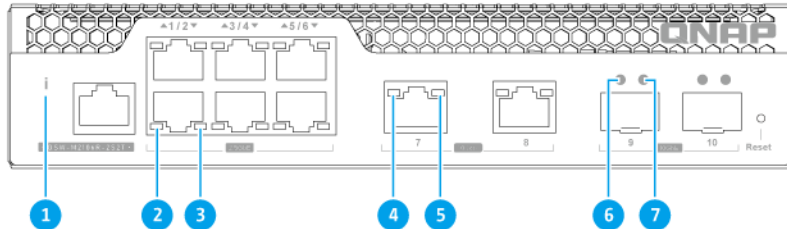

编号	组件	编号	组件
1	交换机状态 LED	5	10GbE RJ45 (5G/2.5G/1G/100M 速度) LED
2	2.5 GbE RJ45 (2.5G 速度) LED	6	10GbE SFP+ (10G 速度) LED
3	2.5 GbE RJ45 (1G/100M 速度) LED	7	10GbE SFP+ (1G 速度) LED
4	10GbE RJ45 (10G 速度) LED	-	-

## 安全信息

以下说明有助于确保个人安全和环境安全。在执行任何操作之前，请仔细阅读这些说明。

### 一般说明

- 设备应存放在通过器具、锁和钥匙或任何安保措施限制进入的安全场所。
- 只有经过授权并掌握技能的合格人员才能实际接触设备，相关人员需了解所有限制措施、安全预防措施和安装维护流程。
- 为避免潜在伤害或组件的损坏，请务必等硬盘和其他内部系统组件冷却后再触碰。
- 请执行静电放电 (ESD) 规程，以避免可能的人员受伤或组件受损。

### 电源

- 为降低失火或触电风险，请确保只将电源线连接到接地良好的电源插座。
- 为避免受到严重伤害，安装或更换系统组件前，必须由经培训的维修技师从设备拔下所有 PSU 线。

### 系统电池

- 此产品配有纽扣电池。
- 如果被吞食，锂纽扣电池可能会在 2 小时内导致严重或致命伤害。

- 请避免儿童接触电池。
- 如果您认为可能电池已被吞食或部于身体的某个部位，请立即就医求助。
- 为避免潜在的电池爆炸、导致人员受伤或组件受损，请确保使用同型电池更换现有电池。
- 请按当地法规或电池制造商的指示正确处置使用过的电池。

### 运动的部件

•



**转动的风扇叶片：**在设备连接到电源时，使您的身体各部位远离正在转动的风扇叶片。

•



**运动的组件：**使您的身体各部位远离正在运动的其他组件。

- 设备不适合在儿童可能会出现的场所使用。

## 2. 安装和访问

本章提供特定硬件安装和交换机访问步骤。

### 安装要求

类别	项目
环境	<ul style="list-style-type: none"> <li>• 室温：0°C 至 40°C (32 至 104°F)</li> <li>• 无冷凝相对湿度：5% 至 95%</li> <li>• 湿球温度：27°C (80.6°F)</li> <li>• 平坦的防静电表面，无直射阳光、液体或化学药剂</li> <li>• 无可能阻塞交换机通风或者压住交换机或电源线的物品。</li> </ul>
硬件和外围设备	<ul style="list-style-type: none"> <li>• 计算机或 NAS</li> <li>• 网线</li> </ul>
工具	<ul style="list-style-type: none"> <li>• 1 号或 2 号十字螺丝刀</li> <li>• 平头螺丝刀</li> <li>• 防静电腕带</li> </ul>

### 设置交换机

1. 将交换机置于符合要求的环境中。  
有关详细信息，请参见[安装要求](#)。
2. 启动交换机。
3. 将交换机连接到计算机或网络。  
有关详细信息，请参见[将交换机连接到计算机](#)。
4. 登录 QSS。

### 安装橡胶垫脚

1. 关闭设备。
2. 从插座上拔下电源线。
3. 拔掉所有线缆和外接部件。
4. 将设备倒置。



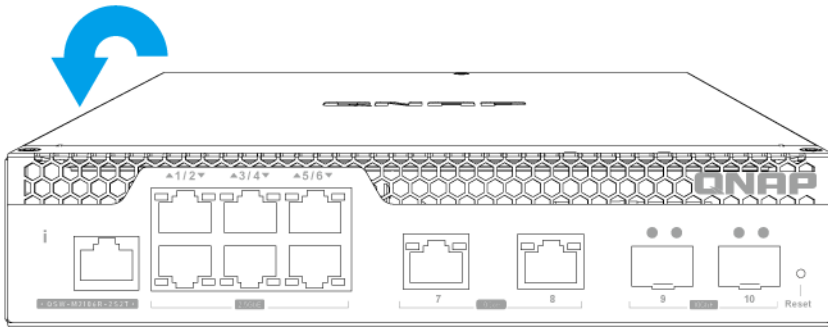

**5. 安装橡胶垫脚。**

- a. 取下橡胶垫脚的保护膜。
- b. 安装橡胶垫脚。

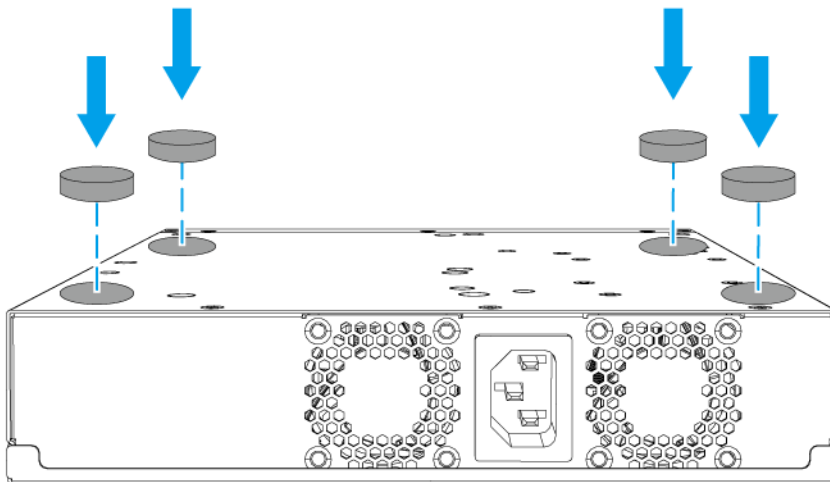

- c. 将设备正常直立放置。

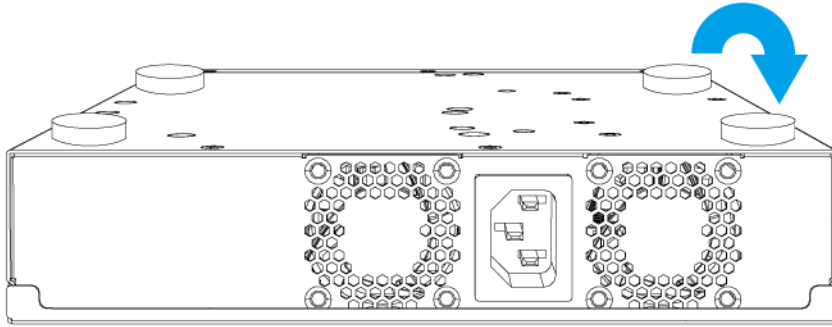

6. 连接所有线缆和外接部件。
7. 将电源线连接到插座。
8. 启动设备。

## 安装手柄

安装手柄可以便于拿取和将设备固定在机架上。

1. 关闭设备。
2. 从插座上拔下电源线。
3. 拔掉所有线缆和外接部件。
4. 将手柄安装到角码上。
  - a. 将手柄上的开孔对准角码上的两个圆螺丝孔。
  - b. 装上螺丝，将手柄固定在角码上。

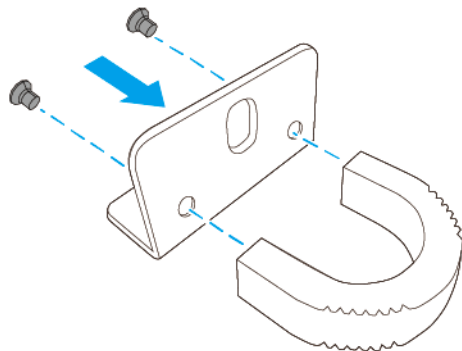

5. 将角码安装到设备上。
  - a. 将角码上的孔对准机箱上的孔。



**注**  
确保手柄与前面板朝向一致。

- b. 装上螺丝，将角码固定到机箱上。

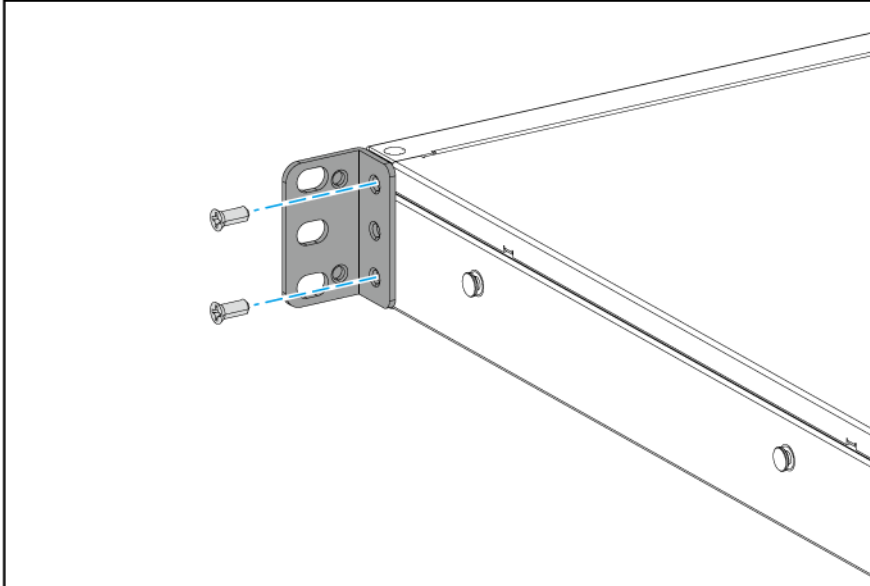

6. 将第二个手柄安装到机箱的另一侧。
7. 连接所有线缆和外接部件。
8. 将电源线连接到插座。
9. 启动设备。

## 将交换机连接到计算机或网络

可以将交换机连接到计算机或局域网。有关详细信息，请参见以下主题：

- [将交换机连接到计算机](#)
- [将交换机连接到网络](#)

## 将交换机连接到计算机

将交换机连接到 QNAP NAS 可以扩展存储容量，还可通过连接到 PoE 或主机端口的网线将数据备份到另一 NAS。但是，必须将交换机连接到计算机才能配置设置。

1. 启动交换机。
2. 将交换机连接到计算机。
  - a. 将网线连接到交换机上的主机端口。
  - b. 将网线连接到计算机上的千兆位网络端口。

- c. 可选: 将交换机连接到 NAS。

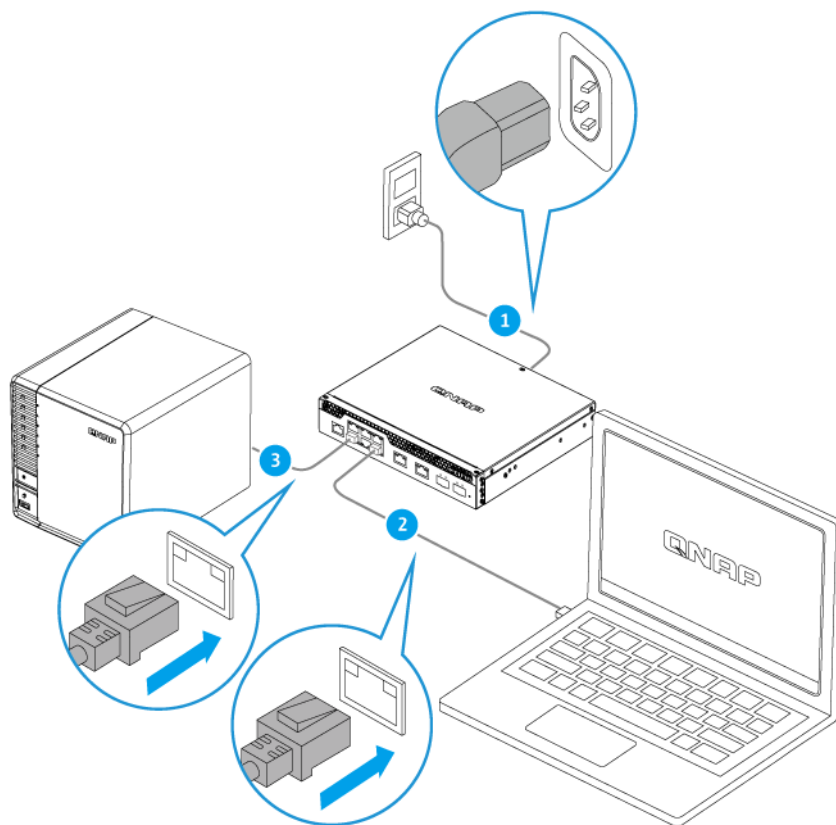

3. 确认计算机可识别交换机。
  - a. 在主机计算机上打开 Qfinder Pro。



**注**  
要下载 Qfinder Pro，请转到 <https://www.qnap.com/utilities>。

- b. 在列表上找到所需交换机。

## 将交换机连接到网络

可以通过主机端口或任何 PoE 端口将交换机连接到局域网。

1. 启动交换机。
2. 通过主机端口将交换机连接到局域网。
3. 在已连接到同一局域网的计算机上运行 Qfinder Pro。



**注**  
要下载 Qfinder Pro，请转到 <https://www.qnap.com/utilities>。

4. 在列表中找到交换机，然后双击名称或 IP 地址。  
此时会出现 QSS 登录屏幕。
5. 输入 QSS 登录信息。

## 6. 单击登录。

### 交换机访问

方式	描述	要求
Web 浏览器	<p>如果您掌握以下信息，便可使用同一网络上的任意计算机访问交换机：</p> <ul style="list-style-type: none"> <li>• 交换机名称（例如：http://example123/）或 IP 地址</li> <li>• 有效用户帐户的登录凭据</li> </ul> <p>有关详细信息，请参见<a href="#">使用浏览器访问交换机</a></p>	<ul style="list-style-type: none"> <li>• 连接到交换机所在网络的计算机</li> <li>• Web 浏览器</li> </ul>
Qfinder Pro	<p>Qfinder Pro 是一个桌面实用工具，可用于在特定网络上查找并访问 QNAP 设备。此实用工具支持 Windows、macOS、Linux 和 Chrome 操作系统。</p> <p>有关详细信息，请参见<a href="#">使用 Qfinder Pro 访问交换机</a>。</p>	<ul style="list-style-type: none"> <li>• 连接到交换机所在网络的计算机</li> <li>• Web 浏览器</li> <li>• Qfinder Pro</li> </ul>

### 使用浏览器访问交换机



如果您知道交换机的 IP 地址和有效用户帐户的登录凭据，便可以使用网络上的任何计算机访问此交换机。QNAP 交换机默认支持 DHCP 客户端配置以进行 IP 分配。连接到网络时，交换机将自动从 DHCP 服务器获取 IP 地址。



#### 注

- 如果不知道交换机的 IP 地址，可以使用 Qfinder Pro 查找该交换机。
- 如果交换机未连接到 DHCP 支持的网路，您可以将计算机的 IP 地址更改为 169.254.100.102 以访问交换机 Web 接口。
- 交换机的默认 IP 地址为 169.254.100.101。

1. 请确认您的计算机与交换机位于同一网络中。
2. 在计算机上打开 Web 浏览器。
3. 在地址栏中键入交换机的 IP 地址。  
此时会出现 QSS 登录页面。
4. 指定默认用户名和密码。

默认用户名	默认密码
admin	<p>交换机映像的 MAC 地址会省略所有标点并大写所有字母。</p> <p> <b>提示</b> 例如，如果 MAC 地址为 00:0a:0b:0c:00:01，则默认密码将为 000A0B0C0001。 您可以使用 Qfinder Pro 找到 MAC 地址。设备上的贴纸也印有带“MAC”字样的 MAC 地址。</p> <p> <b>注</b> 首次登录后，系统将提示您更改密码。 出于安全原因，QNAP 强烈建议首次登录后更改密码。</p>

### 5. 单击登录。

此时会出现 QSS 桌面。



#### 重要

设置交换机之后，请确保将计算机的 IP 地址更改为原始配置。

## 使用 Qfinder Pro 访问交换机

1. 在已连接到交换机所在网络的计算机上安装 Qfinder Pro。



#### 提示

要下载 Qfinder Pro，请转到 <https://www.qnap.com/en/utilities>。

2. 打开 Qfinder Pro。  
Qfinder Pro 会自动搜索网络上的所有 QNAP 设备。
3. 在列表中找到交换机，然后双击名称或 IP 地址。  
QSS 登录屏幕将在默认 Web 浏览器中打开。
4. 指定默认用户名和密码。

默认用户名	默认密码
admin	<p>交换机映像的 MAC 地址会省略所有标点并大写所有字母。</p> <p> <b>提示</b> 例如，如果 MAC 地址为 00:0a:0b:0c:00:01，则默认密码将为 000A0B0C0001。 您可以使用 Qfinder Pro 找到 MAC 地址。设备上的贴纸也印有带“MAC”字样的 MAC 地址。</p>

### 5. 单击登录。

此时会出现 QSS 桌面。

### 3. 基本操作

本章介绍交换机的基本操作。

#### LED

开启交换机电源后，LED 指示灯会指示系统状态和相关信息。以下 LED 信息仅适用于交换机已连接到网络的情况。

有关 LED 位置的详细信息，请参见[前面板 LED](#)。

LED	状态	描述
系统状态	绿色	设备已就绪。
	闪烁绿色	<ul style="list-style-type: none"> <li>设备正在初始化。</li> <li>固件正在更新。</li> </ul> <div style="border-left: 2px solid #0070C0; padding-left: 10px; margin-top: 10px;"> <p><b>注</b> 更新固件时，请勿拔下电源线或 USB 缆线，也不要强行退出应用程序。</p> </div> <ul style="list-style-type: none"> <li>设备正在重置。</li> </ul>
	红色	设备发生致命错误。
	熄灭	设备已关机。
2.5 GbE RJ45 (2.5G 速度)	绿色	链路以 2.5 Gbps 的速度运行。
	闪烁绿色	正在传输数据。
	熄灭	没有网络连接。
2.5 GbE RJ45 (1G/ 100M/10M 速度)	橙色	链路以 1 Gbps 或 100 Mbps 的速度运行。
	闪烁橙色	正在传输数据。
	熄灭	没有网络连接。
10 GbE RJ45 (10G 速度)	绿色	链路以 10 Gbps 的速度运行。
	闪烁绿色	正在传输数据。
	熄灭	没有网络连接。
10 GbE RJ45 (5G/2.5G/1G/ 100M 速度)	橙色	链路以 5 Gbps、2.5 Gbps、1 Gbps 或 100 Mbps 的速度运行。
	闪烁橙色	正在传输数据。
	熄灭	没有网络连接。
10GbE SFP+ (10G 速度)	绿色	链路以 10 Gbps 的速度运行。
	闪烁绿色	正在传输数据。
	熄灭	没有网络连接。
10GbE SFP+ (1G 速度)	橙色	链路以 1 Gbps 的速度运行。
	闪烁橙色	正在传输数据。
	熄灭	没有网络连接。

## 重置按钮

操作	用户操作	结果
基本系统重置	按住此按钮 5 秒钟。	<p>以下设置将重置为默认值：</p> <ul style="list-style-type: none"> <li>系统管理员密码：默认密码为第一个 MAC 地址（去掉特殊字符），以大写字母表示。例如，如果第一个 MAC 地址为 00-08-9B-F6-15-75，则管理员密码为 00089BF61575。</li> </ul> <p> <b>注</b> 您可以使用 Qfinder Pro 找到第一个 MAC 地址，此地址也可能粘贴在设备的标签上，列示为 MAC1。</p> <ul style="list-style-type: none"> <li>admin 帐户将自动启用。</li> </ul>
高级系统重置	按住此按钮 10 秒钟。	恢复默认出厂设置。



## 4. QSS

### 关于 QSS

QNAP 交换机系统 (QSS) 是一个针对 QNAP 交换机设备的网络管理操作系统。QSS 支持第 2 层网络管理功能和交换机系统管理功能。

### 开始使用

1. 以管理员身份登录交换机。  
默认管理员帐户为 `admin`。  
有关详细信息，请参见[交换机访问](#)。
2. 配置系统设置。  
有关详细信息，请参见[系统设置](#)。
3. 配置端口设置和其他网络设置。  
有关详细信息，请参见[网络管理](#)。

### 网络管理

交换机的基本网络配置包括通过服务质量 (QoS) 和访问控制列表 (ACL) 进行的端口管理、VLAN 配置、各类协议的配置，以及流量管理。

### 仪表板

仪表板在接口的配置部分打开。单击仪表板中的下拉菜单，可查看端口状态、VLAN 状态、链路聚合状态以及所有端口的端口流量。

您还可以删除用户配置的网络设置和监控交换机的网络设置。

### 配置端口设置

1. 登录 QSS。
2. 转到 **配置 > 端口管理**。
3. 转到 **端口配置**。
4. 指定一个端口。
5. 配置设置。

设置	描述
状态	控制端口的操作状态
速度	指定端口的最大运行速度
流量控制	控制端口的流量控制状态
	 <b>重要</b> 当端口速度设置为 HDX 时，不支持流量控制。

6. 单击 **保存**。

QSS 随即保存设置。

## 添加 VLAN

虚拟 LAN (VLAN) 将多个网络设备组合在一起并限制广播域。VLAN 的各成员之间彼此隔离，网络流量仅在组成员之间发送。

为每个 VLAN 均分配一个特定的 VLAN 识别码。此 **VLAN** 屏幕显示有关现有 VLAN 的信息，同时还可以通过此屏幕访问 VLAN 配置选项。

1. 登录 QSS。
2. 转到配置 > **VLAN**。
3. 单击**添加**。  
此时会打开**添加 VLAN** 窗口。
4. 指定 VLAN ID。
5. 选择要包括在 VLAN 中的端口。  
仅已标记的端口可以属于多个 VLAN。
6. 单击**保存**。

QSS 随即添加 VLAN。

## 添加链路聚合组 (LAG)

使用链路聚合控制协议 (LACP)，可以将多个网络适配器合并到一个逻辑网络接口中。这可以确保提高吞吐量，并实现冗余。如果某个端口发生故障，流量还会在其余端口继续。

**链路聚合** 页面显示有关现有链路聚合组的信息，同时还可以通过此页面访问配置选项。



### 警告

为防止 LAG 配置过程中发生网络回路错误，在所有设备上配置好 LAG 之前，请勿使用多条网线将交换机连接到其他设备。您可以启用回路保护以避免连接的网路中发生网络回路。

1. 登录 QSS。
2. 转到配置 > **链路聚合**。
3. 指定组。
4. 单击 。  
此时会打开**编辑组**窗口。
5. 配置组设置。

设置	描述
模式	控制组的链路聚合模式 <ul style="list-style-type: none"> <li>• <b>LACP</b>：提供自动故障转移和动态配置</li> <li>• <b>静态</b>：在所选链接聚合端口上同时聚合所有配置</li> </ul> <div style="display: flex; align-items: flex-start;">  <div> <p><b>重要</b></p> <p>在将电缆连接到交换机之前，请先启用链路聚合以免产生数据循环。</p> </div> </div>

设置	描述
端口配置	指定组中要包含哪些端口   <b>注</b> 请确保为 LAG 中的所有成员端口配置相同的设置。

#### 6. 单击**保存**。

QSS 随即更新组设置。



#### 注

将 LAG 分配给 VLAN 时，QNAP 建议从 VLAN 移除单个 LAG 端口成员，然后按需将整个组添加到 VLAN。如果未移除单个端口成员，VLAN 将重置为默认设置。

## 管理快速生成树协议 (RSTP) 设置

RSTP 提供了生成树的快速收敛，并为交换机网络构建了无环路拓扑。RSTP 支持在活动链路发生故障时启用备份链路。



#### 注

- RSTP 默认处于禁用状态。
- 交换机的默认网桥优先级为 32768。

### 配置 RSTP 设置

1. 登录 QSS。
2. 转到**配置 > RSTP**。
3. 更改 RSTP 控制状态。

切换设置	描述
	单击可启用 RSTP 功能。
	单击可禁用 RSTP 功能。

#### 4. 单击**保存**。

QSS 随即保存设置。

### 设置网桥优先级

您可以在 RSTP 配置字段中配置交换机的 RSTP 网桥优先级。

1. 登录 QSS。
2. 转到**配置 > RSTP > RSTP 配置**。
3. 启用 RSTP。



#### 注

有关详细信息，请参见[配置 RSTP 设置](#)。

4. 从下拉列表中选择 RSTP 网桥优先级。

**注**

默认优先级为 32768，对于根网桥优先级，建议将网桥优先级设置为 0。

**5. 单击保存。**

QSS 随即更新 RSTP 网桥优先级。

**配置 LLDP 设置**

链路层发现协议 (LLDP) 使用定期广播在网络上播发设备信息并发现邻近设备。此协议在运行时建立分布式数据库并从网络链路连接的邻近端口收集信息。

**LLDP** 页面显示有关检测到的设备的信息，同时可在此页面启用或禁用 LLDP。

1. 登录 QSS。
2. 转到**配置 > LLDP**。
3. 更改 LLDP 控制状态。

切换设置	用户操作
	单击可启用 LLDP 功能。
	单击可禁用 LLDP 功能。

**4. 单击保存。**

QSS 随即保存设置。

**添加静态 MAC 地址**

MAC 地址表跟踪 MAC 地址并通过特定端口转发相关的单播流量。

1. 登录 QSS。
2. 转到**配置 > LLDP > MAC 地址表**。
3. 指定 MAC 表的老化时间。

**注**

您可以配置条目在 MAC 表中保留的时间。

4. 单击**添加**。  
此时会打开**添加静态 MAC 地址**窗口。
5. 配置 MAC 地址设置。
  - a. 指定 VLAN ID。
  - b. 指定 MAC 地址。
  - c. 至少选择一个端口。

6. 单击**保存**。  
**添加静态 MAC 地址**窗口随即关闭。

QSS 随即添加 MAC 地址。

## 配置 IGMP 侦听

Internet 组管理协议 (IGMP) 管理 IP 多播组的成员关系。IP 主机和相邻的多播路由器使用 IGMP 来建立多播组成员关系。

**IGMP 侦听**页面显示有关检测到的 IGMP 组的信息，同时还可以通过此页面访问 IGMP 侦听配置选项。

1. 登录 QSS。
2. 转到**配置 > IGMP 侦听**。
3. 单击 。  
QSS 随即启用 IGMP 侦听。
4. 配置 IGMP 侦听设置。

设置	描述
多播泛洪阻止	阻止来自未知源的多播泛洪
路由器端口	指定要用作 VLAN 的路由器端口的端口 接收到 IGMP 数据包后，QSS 会通过选定的路由器端口转发流量。
快速离开	指定支持 IGMP v2 快速离开功能的端口。 接收到 IGMP 离开消息后，QSS 会停止向选定的快速离开端口转发多播流量。

5. 单击**保存**。

QSS 随即保存 IGMP 侦听设置。

## 配置 QoS 设置

服务质量(QoS)通过对不同的网络设备和数据包进行分类和优先级排序来改善网络流量的形成。您可以使用 QoS 配置流量策略并在交换机端口上启用这些策略。

要更改端口的 QoS 优先级，请转到**配置 > QoS**，分配 0 到 7 之间的优先级值，然后单击**保存**。



### 注

- QSS 支持从 0 到 7 的八个优先级队列设置，其中 0 表示最低优先级，7 表示最高优先级。优先级最高的端口始终可以先发送数据。
- CoS 和 DSCP 检测设置可以同时禁用，但这些设置不能同时启用。
- 默认情况下，加权循环调度 (WRR) 用作默认 QoS 计划机制。队列权重与从队列发送的数据包数量直接成正比。WRR 可避免低优先级队列中的数据包无法得到服务，并确保交换机优先传输对延迟敏感的数据包。

## 配置 QoS 的 CoS 优先级

CoS（服务等级）是以太网帧标头中的一个 3 位字段。CoS 值根据 CoS 值 (0-7) 决定流量转发到哪个队列。

1. 登录 QSS。
2. 转到**配置 > QoS**。
3. 指定一个端口。

4. 在 CoS 检测下单击 。  
QSS 随即在端口上启用 CoS 检测。
5. 单击**编辑 CoS 检测**。
6. 为 CoS 值分配一个 1 到 8 之间的优先级值。
7. 单击**保存**。  
QSS 更新 CoS 值的优先队列。
8. 单击**保存**。

QSS 随即更新 QoS 信息。

### 配置 QoS 的 DSCP 优先级

DSCP（差分服务代码点）是数据包 IP 标头中的一个对数据包进行分类的 6 位字段。DSCP 值根据分配给 DSCP 值 (0-63) 的优先级决定数据包转发到哪个队列。

1. 登录 QSS。
2. 转到**配置 > QoS**。
3. 指定一个端口。
4. 在 DSCP 检测下单击 。  
QSS 随即在端口上启用 DSCP 检测。
5. 单击**编辑 DSCP 检测**。
6. 为 DSCP 值分配一个 1 到 8 之间的优先级值。
7. 单击**保存**。  
QSS 随即更新 DSCP 值的优先队列。
8. 单击**保存**。

QSS 随即更新 QoS 信息。

### 管理访问控制列表 (ACL) 条目

通过访问控制列表，可以使用受控规则集处理交换机内的网络流量。每个 ACL 规则专用于一组用户创建的条件，数据包必须满足这些条件才能匹配规则。在数据包没有可匹配的 ACL 规则的情况下，交换机将应用默认规则。否则，交换机会将数据包与规则进行匹配，并允许或拒绝该数据包。

您可以使用 ACL 控制主机对网络不同部分的访问，或在交换机级别下控制流量转发或阻止。

#### 添加基于 IP 地址的 ACL 规则

1. 登录 QSS。
2. 转到**配置 > ACL > 按 IP 地址**。
3. 单击**添加**。  
此时会打开**添加 ACL - IP 地址**窗口。
4. 配置 ACL 设置。

设置	用户操作
ACL 编号	请指定介于 1 到 255 之间的数字。
来源	
IP 地址	指定来源 IP 地址。
子网掩码	指定源子网掩码。
目标	
IP 地址	指定目标 IP 地址。
子网掩码	指定目标子网掩码。
端口	选择特定端口以应用 ACL 规则，或选择 <b>全部</b> ，将规则应用于所有端口。
权限	选择以下选项之一： <ul style="list-style-type: none"> <li>• 允许</li> <li>• 拒绝</li> </ul>

**5. 单击保存。**

QSS 随即添加基于 IP 地址的 ACL 规则。

### 添加基于 MAC 地址的 ACL 规则

1. 登录 QSS。
2. 转到**配置 > ACL > 按 MAC 地址**。
3. 单击**添加**。  
此时会打开**添加 ACL - MAC 地址**窗口。
4. 配置 ACL 设置。

设置	用户操作
ACL 编号	请指定介于 1 到 255 之间的数字。
来源	
MAC 地址	指定源 MAC 地址。
目标	
MAC 地址	指定目标 MAC 地址。
端口	选择特定端口以应用 ACL 规则，或选择 <b>全部</b> ，将规则应用于所有端口。
权限	选择以下选项之一： <ul style="list-style-type: none"> <li>• 允许</li> <li>• 拒绝</li> </ul>

**5. 单击保存。**

QSS 随即添加基于 MAC 地址的 ACL 规则。

### 删除网络设置

1. 登录 QSS。
2. 转到**配置**。

3. 选择网络设置。

**注**

删除网络设置仅适用于 ACL 规则、链路聚合组、静态 MAC 地址和 VLAN。

4. 单击 。  
此时会出现确认消息。
5. 单击删除。

QSS 随即删除网络设置。

## 监控网络设置

您可以在**配置**部分监控以下网络设置。这些设置可用于监控和诊断交换机操作。

1. 登录 QSS。
2. 转到配置。
3. 选择网络设置。

设置	描述
<b>IGMP 侦听统计信息</b>	转到 <b>IGMP 侦听 &gt; IGMP 侦听统计信息</b> 。 显示有关已检测到的 IGMP 组的统计信息。
<b>LLDP 远程设备</b>	转到 <b>LLDP &gt; LLDP 远程设备</b> 。 显示支持 LLDP 的端口的信息，包括系统功能和远程管理 IP 地址。 可能的系统功能包括： <ul style="list-style-type: none"> <li>• 桥接器</li> <li>• DOCSIS 线缆设备</li> <li>• 中继器</li> <li>• 保留</li> <li>• 路由器</li> <li>• 仅工作站</li> <li>• 电话</li> <li>• WLAN 接入点</li> <li>• 其他</li> </ul>
<b>端口状态</b>	转到 <b>端口管理 &gt; 端口状态</b> ，查看以下端口状态信息： <ul style="list-style-type: none"> <li>• 端口号</li> <li>• 端口链路状态</li> <li>• 端口状态</li> <li>• 端口速度</li> <li>• 流量控制</li> </ul>



设置	描述
端口统计信息	<p>a. 转到<b>端口管理 &gt; 端口统计信息</b>，查看网络端口的统计信息。</p> <p>b. 单击 ，将查看选项更改为列表视图。</p>



## 系统管理

可在**系统**部分访问设备配置选项。

## 系统设置

**系统设置**菜单包含交换机的系统信息、IP 信息、密码设置、安全连接设置以及时间设置等系统配置选项。

### 更改交换机名称

1. 登录 QSS。
2. 转到**系统 > 系统设置 > 系统信息**。
3. 单击 。
4. 指定交换机名称。  
要求：
  - 长度：1-14 个字符
  - 有效字符：A-Z、a-z、0-9
  - 有效特殊字符：连字符 (-)
5. 单击  确认交换机名称。

QSS 随即更新交换机名称。

### 配置交换机 IP 信息

1. 登录 QSS。
2. 转到**系统 > 系统设置 > IP**。
3. 选择网络配置设置。

设置	描述
自动获取 IP 与 DNS	如果网络支持 DHCP，则适配器会自动获取 IP 地址和网络设置。

设置	描述
手动设置 IP 与 DNS	<p>手动分配静态 IP 地址。您必须指定以下信息：</p> <ul style="list-style-type: none"> <li>• 固定 IP 地址</li> <li>• 子网掩码</li> <li>• 默认网关</li> </ul> <p> <b>注</b> 交换机的默认网关 IP 地址是可选的。</p>

4. 单击**保存**。  
此时会出现确认消息。
5. 单击**是**。

QSS 随即更新 IP 信息。



**注**  
使用 Qfinder Pro 查找交换机并登录到 QSS。

## 更新交换机密码

1. 登录 QSS。
2. 转到**系统 > 系统设置 > 密码**。
3. 指定一个新密码。



**提示**  
单击  可显示密码。

设置	用户操作
当前密码	指定设备的当前密码
新密码	指定包含 8 至 20 个 ASCII 字符的密码。
确认新密码	重新输入新密码

4. 单击**保存**。

QSS 随即从交换机界面中将您注销。您可以使用新密码访问交换机。

## 配置时间设置



**注**  
必须正确配置系统时间以确保下列各项：

- 使用 Web 浏览器连接到设备或保存文件时，显示的操作时间正确。
- 事件日志反映事件发生的确切时间。
- 计划性任务在正确的时间运行。

1. 登录 QSS。
2. 转到**系统 > 系统设置 > 时间**。

3. 指定时区。
4. 指定时间配置。

设置	描述
手动配置	指定日期和时间。
与 Internet 时间服务器同步	确保设备连接到 Internet，然后指定以下信息： <b>服务器：</b> 指定网络时间协议 (NTP) 服务器。 示例：time.nist.gov、time.windows.com

5. 单击保存。

QSS 随即更新时间设置。

## 备份系统设置

1. 登录 QSS。
2. 转到**系统 > 系统设置 > 备份和恢复**。
3. 单击**备份**。

设备会将系统设置导出为 BIN 文件，并将该文件下载至计算机。

## 恢复系统设置



### 警告

如果选定的备份文件包含设备上已存在的用户或用户组信息，系统将覆盖现有信息。

1. 登录 QSS。
2. 转到**系统 > 系统设置 > 备份和恢复**。  
此时会打开文件资源管理器窗口。
3. 单击**浏览**。
4. 选择包含设备系统设置的有效 BIN 文件。
5. 单击**恢复**。

QSS 恢复交换机设置。

## 重置交换机密码

1. 登录 QSS。
2. 转到**系统 > 系统设置 > 恢复出厂设置**。
3. 单击**密码重置**。

QSS 随即重置交换机密码。

默认用户名	默认密码
admin	<p>交换机映像的 MAC 地址会省略所有标点并大写所有字母。</p> <p> <b>提示</b> 例如，如果 MAC 地址为 00:0a:0b:0c:00:01，则默认密码为 000A0B0C0001。 您可以使用 Qfinder Pro 找到 MAC 地址。设备上的贴纸也印有带“MAC”字样的 MAC 地址。</p>

## 将交换机重置为出厂设置

重置交换机会删除设备上存储的数据，并将交换机恢复到默认的出厂设置。



### 提示

还可以按住实体重置按钮 10 秒，将交换机重置为出厂默认设置。

1. 登录 QSS。
2. 转到**系统 > 系统设置 > 恢复出厂设置**。
3. 单击**恢复出厂设置**。  
此时会出现确认消息。
4. 单击**是**。

QSS 随即将交换机重置为出厂默认设置。



### 注

要再次登录到界面，必须使用 Qfinder Pro 查找设备。有关详细信息，请参见[交换机访问](#)。

## 启用安全连接 (HTTPS)

1. 登录 QSS。
2. 转到**系统 > 系统设置 > HTTPS**。
3. 选择**启用安全连接(HTTPS)**。
4. 选择 TLS 版本。



### 注

选择 TLS 的最新版本以最大程度地提高系统安全性。确保系统满足 TLS 要求以避免兼容性问题。

5. 可选: 选择**强制使用安全连接(HTTPS)**。



### 注



启用此设置后，仅可通过 HTTPS 访问 Web 管理页面。

6. 单击**保存**。

QSS 随即保存安全连接设置。

## 重新启动交换机

1. 登录 QSS。

2.  单击位于页面右上角的 。
3. 单击**重新启动交换机**。  
此时会出现确认消息。
4. 单击**是**。

QSS 随即重新启动交换机。

## 查看交换机信息

要查看交换机的硬件和系统信息，可以转到**系统 > 系统信息**。

该屏幕提供以下信息。

信息	描述
交换机名称	显示设备的默认名称或修改后的名称
型号名称	显示交换机的型号名称
MAC 地址	显示交换机映像的 MAC 地址
IP 地址	显示交换机的 DHCP 或静态 IP 地址
系统运行时间	显示系统的运行时间
当前固件版本	显示交换机的固件映像版本

## 固件更新

QNAP 建议设备固件始终保持最新版本。这可确保您的设备可以从新 QSS 软件功能、安全更新、增强功能和错误修复中获益。

可以使用以下方法之一更新交换机固件：

更新方法	描述
使用 <b>检查更新</b> 。	QSS 会自动检测固件更新并将其安装到您的设备上。 有关详细信息，请参见 <a href="#">检查实时更新</a> 。
使用 <b>固件更新</b>	您可以在 <a href="#">QNAP 网站</a> 上检查固件更新，将固件更新下载到计算机并将固件更新手动安装到您的设备。 有关详细信息，请参见 <a href="#">手动更新固件</a> 。

## 固件要求

设备必须符合以下要求才能执行固件更新：

设置	要求
硬件设置	<ul style="list-style-type: none"> <li>一台计算机</li> </ul> <p> <b>注</b> 手动或通过 Qfinder Pro 更新固件时，需要一台计算机。</p> <p>以太网线</p> <p> <b>注</b> QNAP 建议使用有线以太网连接更新固件，以确保在固件更新过程中网络连接保持稳定。</p>
备份系统设置	QNAP 建议在更新固件前将系统设置备份到计算机。有关详细信息，请参见 <a href="#">备份系统设置</a> 。
管理员权限	您必须是交换机管理员或具有管理权限才能更新固件。
停止交换机操作	QNAP 建议在固件更新前停止所有其他交换机操作。要使固件更新生效，必须重新启动交换机，并且可能会中断正在进行的交换机服务或操作。
设备型号名称	<p>确保您具有正确的交换机型号名称。您可以使用以下方法找到交换机型号名称：</p> <ul style="list-style-type: none"> <li>在设备底部或后面的贴纸上找到设备型号名称。</li> <li>转到<a href="#">控制台</a> &gt; <a href="#">系统状态</a> &gt; <a href="#">系统信息</a> &gt; <a href="#">型号名称</a></li> </ul>
固件版本	如果正在使用 <a href="#">固件更新</a> 或 Qfinder Pro 更新固件，请确保所选固件版本适用于您的设备型号。

## 检查实时更新



### 警告

- 为防止数据丢失，QNAP 建议您在更新固件前备份设备上的所有数据。有关数据备份的详细信息，请参见[备份系统设置](#)。
- 在固件更新过程中不要关闭设备。



### 重要

- 在更新固件前，确保您已查看[固件要求](#)的全部内容。
- 更新可能需要花费数分钟或更长时间，具体取决于硬件配置和网络连接。

1. 登录 QSS。
2. 转到[系统](#) > [固件更新](#) > [实时更新](#)。
3. 单击[刷新检查](#)。  
QSS 将检查是否有固件更新可用。如果有可用更新，您可以选择更新 QSS。
4. 单击[更新系统](#)。  
此时会出现确认消息。
5. 单击[更新](#)。

QSS 随即更新固件。

## 手动更新固件



### 警告

- 为防止数据丢失，QNAP 建议您在更新固件前备份设备上的所有数据。有关数据备份的详细信息，请参见[备份系统设置](#)。
- 在固件更新过程中不要关闭设备。



### 重要

- 在更新固件前，确保您已查看[固件要求](#)的全部内容。
- 更新可能需要花费数分钟或更长时间，具体取决于硬件配置和网络连接。

1. 下载设备固件。
  - a. 转到 <http://www.qnap.com/download>。
  - b. 选择产品类型。
  - c. 选择您的设备型号。
  - d. 阅读发行说明并确认以下信息：
    - 设备型号与固件版本匹配。
    - 需要更新固件。
    - 检查是否有其他固件更新设置说明。
2. 确保产品型号与固件正确。
3. 根据您的位置选择下载服务器。
4. 下载固件包。
5. 单击**浏览**。
6. 选择一个文件夹。
7. 保存下载的固件包。
8. 解压缩固件映像文件。
9. 登录 QSS。
10. 转到**系统 > 固件更新 > 固件更新**。
11. 单击**浏览**，然后选择解压缩后的固件映像文件。
12. 单击**更新系统**。  
此时会出现确认消息窗口。
13. 单击**更新**。

设备会立即重新启动。

## 手动更新固件



### 警告

- 为防止数据丢失，QNAP 建议您在更新固件前备份设备上的所有数据。有关数据备份的详细信息，请参见。
- 在固件更新过程中不要关闭设备。



### 重要

- 在更新固件前，确保您已查看的全部内容。
- 更新可能需要花费数分钟或更长时间，具体取决于硬件配置和网络连接。

1. 下载设备固件。
  - a. 转到 <http://www.qnap.com/download>。
  - b. 选择产品类型。
  - c. 选择您的设备型号。
  - d. 阅读发行说明并确认以下信息：
    - 设备型号与固件版本匹配。
    - 需要更新固件。
    - 检查是否有其他固件更新设置说明。
2. 确保产品型号与固件正确。
3. 根据您的位置选择下载服务器。
4. 下载固件包。
5. 单击**浏览**。
6. 选择一个文件夹。
7. 保存下载的固件包。
8. 解压缩固件映像文件。
9. 登录 QSS。
10. 转到**系统管理 > 固件更新 > 固件更新**。
11. 转到**系统 > 固件更新 > 固件更新**。
12. 单击**浏览**，然后选择解压缩后的固件映像文件。
13. 单击**更新系统**。  
此时会出现确认消息窗口。
14. 单击**更新**。

设备会立即重新启动。



## 5. 支持和其他资源

QNAP 提供了以下资源：

资源	URL
文档	<a href="https://docs.qnap.com">https://docs.qnap.com</a>
服务门户	<a href="https://service.qnap.com">https://service.qnap.com</a>
下载	<a href="https://download.qnap.com">https://download.qnap.com</a>
社区论坛	<a href="https://forum.qnap.com">https://forum.qnap.com</a>

## 6. 术语表

### **myQNAPcloud**

提供各种远程访问服务，如 DDNS 和 myQNAPcloud Link

### **Qfinder Pro**

一种 QNAP 实用工具，可用于查找和访问局域网中的 QNAP NAS 设备

### **QSS**

QNAP 交换机管理应用程序

### **QuNetSwitch**

QNAP 运行的 QNAP 交换机 QTS 应用

## 7. 声明

本章提供有关保修、免责声明、许可和联邦法规的信息。

### 有限保修

QNAP 为本公司产品提供有限保修服务。自发票注明日期起一 (1) 年或更长期限内, QNAP 品牌的硬件产品享受材料和工方面艺缺陷的保修服务。("保修期")。请访问 [www.qnap.com/warranty](http://www.qnap.com/warranty) 查看您的法定权利 (QNAP 可不时自行修改这些权利)。

### 免责声明

本文档中提供的信息与 QNAP Systems, Inc. (即 "QNAP") 的产品有关。本文档未通过禁止反言或其他方式授予对任何知识产权的明示或暗示许可。除非在 QNAP 针对此类产品的销售条款和条件中明确注明, QNAP 不承担任何责任, 并且 QNAP 不提供任何与 QNAP 产品的销售和/或使用有关的明示或暗示的担保, 包括与特定用途的适用性、适销性或者侵犯任何专利、版权或其他知识产权有关的责任或担保。

QNAP 产品不适用于医疗、救生、生命维持、关键控制、安全系统或核设施应用。

在任何情况下, 对于因使用本产品、其随附软件或文档而导致的直接、间接、特殊、偶发或继发损失, QNAP 的赔偿责任均不超出产品售价。QNAP 对其产品或本文档的内容或使用以及所有随附软件, 不做任何明示、暗示或法定的保证或表述, 并特别声明, 不保证其质量、性能、适销性或适用于任何特定用途。QNAP 保留修改或更新其产品、软件或文档的权利, 无需通知任何个人或实体。

建议定期备份系统, 以避免任何潜在的数据丢失。QNAP 对所有类型的数据丢失或恢复不承担任何责任。

如果退回 QNAP 产品 (例如 NAS, 网络连接存储) 包装中的任何组件进行退款或维修, 请务必妥善包装以便运输。对于因包装不当而造成的任何形式的损坏, QNAP 将不予赔偿。

所有特性、功能和其他产品规格如有更改, 恕不另行通知, 亦不承担任何责任。本文所包含的信息如有更改, 恕不另行通知。

此外, 文中未使用 ® 或 ™ 符号。

### GNU Public License

Version 3, 29 June 2007

Everyone is permitted to copy and distribute verbatim copies of this license document, but changing it is not allowed.

#### Preamble

The GNU General Public License is a free, copy left license for software and other kinds of works.

The licenses for most software and other practical works are designed to take away your freedom to share and change the works. By contrast, the GNU General Public License is intended to guarantee your freedom to share and change all versions of a program--to make sure it remains free software for all its users. We, the Free Software Foundation, use the GNU General Public License for most of our software; it applies also to any other work released this way by its authors. You can apply it to your programs, too.

When we speak of free software, we are referring to freedom, not price. Our General Public Licenses are designed to make sure that you have the freedom to distribute copies of free software (and charge for them if you wish), that you receive source code or can get it if you want it, that you can change the software or use pieces of it in new free programs, and that you know you can do these things.

To protect your rights, we need to prevent others from denying you these rights or asking you to surrender the rights. Therefore, you have certain responsibilities if you distribute copies of the software, or if you modify it: responsibilities to respect the freedom of others.

For example, if you distribute copies of such a program, whether gratis or for a fee, you must pass on to the recipients the same freedoms that you received. You must make sure that they, too, receive or can get the source code. And you must show them these terms so they know their rights.

Developers that use the GNU GPL protect your rights with two steps: (1) assert copyright on the software, and (2) offer you this License giving you legal permission to copy, distribute and/or modify it.

For the developers' and authors' protection, the GPL clearly explains that there is no warranty for this free software. For both users' and authors' sake, the GPL requires that modified versions be marked as changed, so that their problems will not be attributed erroneously to authors of previous versions.

Some devices are designed to deny users access to install or run modified versions of the software inside them, although the manufacturer can do so. This is fundamentally incompatible with the aim of protecting users' freedom to change the software. The systematic pattern of such abuse occurs in the area of products for individuals to use, which is precisely where it is most unacceptable. Therefore, we have designed this version of the GPL to prohibit the practice for those products. If such problems arise substantially in other domains, we stand ready to extend this provision to those domains in future versions of the GPL, as needed to protect the freedom of users.

Finally, every program is threatened constantly by software patents. States should not allow patents to restrict development and use of software on general-purpose computers, but in those that do, we wish to avoid the special danger that patents applied to a free program could make it effectively proprietary. To prevent this, the GPL assures that patents cannot be used to render the program non-free.

The precise terms and conditions for copying, distribution and modification follow.

## Terms and Conditions

### 1. Definitions.

"This License" refers to version 3 of the GNU General Public License.

"Copyright" also means copyright-like laws that apply to other kinds of works, such as semiconductor masks.

"The Program" refers to any copyrightable work licensed under this License. Each licensee is addressed as "you". "Licensees" and "recipients" may be individuals or organizations.

To "modify" a work means to copy from or adapt all or part of the work in a fashion requiring copyright permission, other than the making of an exact copy. The resulting work is called a "modified version" of the earlier work or a work "based on" the earlier work.

A "covered work" means either the unmodified Program or a work based on the Program.

To "propagate" a work means to do anything with it that, without permission, would make you directly or secondarily liable for infringement under applicable copyright law, except executing it on a computer or modifying a private copy. Propagation includes copying, distribution (with or without modification), making available to the public, and in some countries other activities as well.

To "convey" a work means any kind of propagation that enables other parties to make or receive copies. Mere interaction with a user through a computer network, with no transfer of a copy, is not conveying.

An interactive user interface displays "Appropriate Legal Notices" to the extent that it includes a convenient and prominently visible feature that (1) displays an appropriate copyright notice, and (2) tells the user that there is no warranty for the work (except to the extent that warranties are provided), that licensees may convey the work under this License, and how to view a copy of this License. If the interface presents a list of user commands or options, such as a menu, a prominent item in the list meets this criterion.

### 2. Source Code.

The “source code” for a work means the preferred form of the work for making modifications to it. “Object code” means any non-source form of a work.

A “Standard Interface” means an interface that either is an official standard defined by a recognized standards body, or, in the case of interfaces specified for a particular programming language, one that is widely used among developers working in that language.

The “System Libraries” of an executable work include anything, other than the work as a whole, that (a) is included in the normal form of packaging a Major Component, but which is not part of that Major Component, and (b) serves only to enable use of the work with that Major Component, or to implement a Standard Interface for which an implementation is available to the public in source code form. A “Major Component”, in this context, means a major essential component (kernel, window system, and so on) of the specific operating system (if any) on which the executable work runs, or a compiler used to produce the work, or an object code interpreter used to run it.

The “Corresponding Source” for a work in object code form means all the source code needed to generate, install, and (for an executable work) run the object code and to modify the work, including scripts to control those activities. However, it does not include the work’s System Libraries, or general-purpose tools or generally available free programs which are used unmodified in performing those activities but which are not part of the work. For example, Corresponding Source includes interface definition files associated with source files for the work, and the source code for shared libraries and dynamically linked subprograms that the work is specifically designed to require, such as by intimate data communication or control flow between those subprograms and other parts of the work.

The Corresponding Source need not include anything that users can regenerate automatically from other parts of the Corresponding Source.

The Corresponding Source for a work in source code form is that same work.

### 3. Basic Permissions.

All rights granted under this License are granted for the term of copyright on the Program, and are irrevocable provided the stated conditions are met. This License explicitly affirms your unlimited permission to run the unmodified Program. The output from running a covered work is covered by this License only if the output, given its content, constitutes a covered work. This License acknowledges your rights of fair use or other equivalent, as provided by copyright law.

You may make, run and propagate covered works that you do not convey, without conditions so long as your license otherwise remains in force. You may convey covered works to others for the sole purpose of having them make modifications exclusively for you, or provide you with facilities for running those works, provided that you comply with the terms of this License in conveying all material for which you do not control copyright. Those thus making or running the covered works for you must do so exclusively on your behalf, under your direction and control, on terms that prohibit them from making any copies of your copyrighted material outside their relationship with you.

Conveying under any other circumstances is permitted solely under the conditions stated below. Sublicensing is not allowed; section 10 makes it unnecessary.

### 4. Protecting Users' Legal Rights From Anti-Circumvention Law.

No covered work shall be deemed part of an effective technological measure under any applicable law fulfilling obligations under article 11 of the WIPO copyright treaty adopted on 20 December 1996, or similar laws prohibiting or restricting circumvention of such measures.

When you convey a covered work, you waive any legal power to forbid circumvention of technological measures to the extent such circumvention is effected by exercising rights under this License with respect to the covered work, and you disclaim any intention to limit operation or modification of the work as a means of enforcing, against the work’s users, your or third parties’ legal rights to forbid circumvention of technological measures.

### 5. Conveying Verbatim Copies.

You may convey verbatim copies of the Program’s source code as you receive it, in any medium, provided that you conspicuously and appropriately publish on each copy an appropriate copyright notice; keep intact all notices stating that this License and any non-permissive terms added in accord with section 7 apply to the code; keep intact all notices of the absence of any warranty; and give all recipients a copy of this License along with the Program.

You may charge any price or no price for each copy that you convey, and you may offer support or warranty protection for a fee.

#### 6. Conveying Modified Source Versions.

You may convey a work based on the Program, or the modifications to produce it from the Program, in the form of source code under the terms of section 4, provided that you also meet all of these conditions:

- a. The work must carry prominent notices stating that you modified it, and giving a relevant date.
- b. The work must carry prominent notices stating that it is released under this License and any conditions added under section 7. This requirement modifies the requirement in section 4 to “keep intact all notices”.
- c. You must license the entire work, as a whole, under this License to anyone who comes into possession of a copy. This License will therefore apply, along with any applicable section 7 additional terms, to the whole of the work, and all its parts, regardless of how they are packaged. This License gives no permission to license the work in any other way, but it does not invalidate such permission if you have separately received it.
- d. If the work has interactive user interfaces, each must display Appropriate Legal Notices; however, if the Program has interactive interfaces that do not display Appropriate Legal Notices, your work need not make them do so.  
A compilation of a covered work with other separate and independent works, which are not by their nature extensions of the covered work, and which are not combined with it such as to form a larger program, in or on a volume of a storage or distribution medium, is called an “aggregate” if the compilation and its resulting copyright are not used to limit the access or legal rights of the compilation's users beyond what the individual works permit. Inclusion of a covered work in an aggregate does not cause this License to apply to the other parts of the aggregate.

#### 7. Conveying Non-Source Forms.

You may convey a covered work in object code form under the terms of sections 4 and 5, provided that you also convey the machine-readable Corresponding Source under the terms of this License, in one of these ways:

- a. Convey the object code in, or embodied in, a physical product (including a physical distribution medium), accompanied by the Corresponding Source fixed on a durable physical medium customarily used for software interchange.
- b. Convey the object code in, or embodied in, a physical product (including a physical distribution medium), accompanied by a written offer, valid for at least three years and valid for as long as you offer spare parts or customer support for that product model, to give anyone who possesses the object code either (1) a copy of the Corresponding Source for all the software in the product that is covered by this License, on a durable physical medium customarily used for software interchange, for a price no more than your reasonable cost of physically performing this conveying of source, or (2) access to copy the Corresponding Source from a network server at no charge.
- c. Convey individual copies of the object code with a copy of the written offer to provide the Corresponding Source. This alternative is allowed only occasionally and noncommercially, and only if you received the object code with such an offer, in accord with subsection 6b.
- d. Convey the object code by offering access from a designated place (gratis or for a charge), and offer equivalent access to the Corresponding Source in the same way through the same place at no further charge. You need not require recipients to copy the Corresponding Source along with the object code. If the place to copy the object code is a network server, the Corresponding Source may be on a different server (operated by you or a third party) that supports equivalent copying facilities, provided you maintain clear directions next to the object code saying where to

find the Corresponding Source. Regardless of what server hosts the Corresponding Source, you remain obligated to ensure that it is available for as long as needed to satisfy these requirements.

- e. Convey the object code using peer-to-peer transmission, provided you inform other peers where the object code and Corresponding Source of the work are being offered to the general public at no charge under subsection 6d.

A separable portion of the object code, whose source code is excluded from the Corresponding Source as a System Library, need not be included in conveying the object code work.

A "User Product" is either (1) a "consumer product", which means any tangible personal property which is normally used for personal, family, or household purposes, or (2) anything designed or sold for incorporation into a dwelling. In determining whether a product is a consumer product, doubtful cases shall be resolved in favor of coverage. For a particular product received by a particular user, "normally used" refers to a typical or common use of that class of product, regardless of the status of the particular user or of the way in which the particular user actually uses, or expects or is expected to use, the product. A product is a consumer product regardless of whether the product has substantial commercial, industrial or non-consumer uses, unless such uses represent the only significant mode of use of the product.

"Installation Information" for a User Product means any methods, procedures, authorization keys, or other information required to install and execute modified versions of a covered work in that User Product from a modified version of its Corresponding Source. The information must suffice to ensure that the continued functioning of the modified object code is in no case prevented or interfered with solely because modification has been made.

If you convey an object code work under this section in, or with, or specifically for use in, a User Product, and the conveying occurs as part of a transaction in which the right of possession and use of the User Product is transferred to the recipient in perpetuity or for a fixed term (regardless of how the transaction is characterized), the Corresponding Source conveyed under this section must be accompanied by the Installation Information. But this requirement does not apply if neither you nor any third party retains the ability to install modified object code on the User Product (for example, the work has been installed in ROM).

The requirement to provide Installation Information does not include a requirement to continue to provide support service, warranty, or updates for a work that has been modified or installed by the recipient, or for the User Product in which it has been modified or installed. Access to a network may be denied when the modification itself materially and adversely affects the operation of the network or violates the rules and protocols for communication across the network.

Corresponding Source conveyed, and Installation Information provided, in accord with this section must be in a format that is publicly documented (and with an implementation available to the public in source code form), and must require no special password or key for unpacking, reading or copying.

## 8. Additional Terms.

"Additional permissions" are terms that supplement the terms of this License by making exceptions from one or more of its conditions. Additional permissions that are applicable to the entire Program shall be treated as though they were included in this License, to the extent that they are valid under applicable law. If additional permissions apply only to part of the Program, that part may be used separately under those permissions, but the entire Program remains governed by this License without regard to the additional permissions.

When you convey a copy of a covered work, you may at your option remove any additional permissions from that copy, or from any part of it. (Additional permissions may be written to require their own removal in certain cases when you modify the work.) You may place additional permissions on material, added by you to a covered work, for which you have or can give appropriate copyright permission.

Notwithstanding any other provision of this License, for material you add to a covered work, you may (if authorized by the copyright holders of that material) supplement the terms of this License with terms:

- a. Disclaiming warranty or limiting liability differently from the terms of sections 15 and 16 of this License; or
- b. Requiring preservation of specified reasonable legal notices or author attributions in that material or in the Appropriate Legal Notices displayed by works containing it; or
- c. Prohibiting misrepresentation of the origin of that material, or requiring that modified versions of such material be marked in reasonable ways as different from the original version; or
- d. Limiting the use for publicity purposes of names of licensors or authors of the material; or
- e. Declining to grant rights under trademark law for use of some trade names, trademarks, or service marks; or
- f. Requiring indemnification of licensors and authors of that material by anyone who conveys the material (or modified versions of it) with contractual assumptions of liability to the recipient, for any liability that these contractual assumptions directly impose on those licensors and authors. All other non-permissive additional terms are considered “further restrictions” within the meaning of section 10. If the Program as you received it, or any part of it, contains a notice stating that it is governed by this License along with a term that is a further restriction, you may remove that term. If a license document contains a further restriction but permits relicensing or conveying under this License, you may add to a covered work material governed by the terms of that license document, provided that the further restriction does not survive such relicensing or conveying.  
If you add terms to a covered work in accord with this section, you must place, in the relevant source files, a statement of the additional terms that apply to those files, or a notice indicating where to find the applicable terms.  
Additional terms, permissive or non-permissive, may be stated in the form of a separately written license, or stated as exceptions; the above requirements apply either way.

#### 9. Termination.

You may not propagate or modify a covered work except as expressly provided under this License. Any attempt otherwise to propagate or modify it is void, and will automatically terminate your rights under this License (including any patent licenses granted under the third paragraph of section 11).

However, if you cease all violation of this License, then your license from a particular copyright holder is reinstated (a) provisionally, unless and until the copyright holder explicitly and finally terminates your license, and (b) permanently, if the copyright holder fails to notify you of the violation by some reasonable means prior to 60 days after the cessation.

Moreover, your license from a particular copyright holder is reinstated permanently if the copyright holder notifies you of the violation by some reasonable means, this is the first time you have received notice of violation of this License (for any work) from that copyright holder, and you cure the violation prior to 30 days after your receipt of the notice.

Termination of your rights under this section does not terminate the licenses of parties who have received copies or rights from you under this License. If your rights have been terminated and not permanently reinstated, you do not qualify to receive new licenses for the same material under section 10.

#### 10. Acceptance Not Required for Having Copies.

You are not required to accept this License in order to receive or run a copy of the Program. Ancillary propagation of a covered work occurring solely as a consequence of using peer-to-peer transmission to receive a copy likewise does not require acceptance. However, nothing other than this License grants you permission to propagate or modify any covered work. These actions infringe copyright if you do not accept this License. Therefore, by modifying or propagating a covered work, you indicate your acceptance of this License to do so.

#### 11. Automatic Licensing of Downstream Recipients.



Each time you convey a covered work, the recipient automatically receives a license from the original licensors, to run, modify and propagate that work, subject to this License. You are not responsible for enforcing compliance by third parties with this License.

An “entity transaction” is a transaction transferring control of an organization, or substantially all assets of one, or subdividing an organization, or merging organizations. If propagation of a covered work results from an entity transaction, each party to that transaction who receives a copy of the work also receives whatever licenses to the work the party's predecessor in interest had or could give under the previous paragraph, plus a right to possession of the Corresponding Source of the work from the predecessor in interest, if the predecessor has it or can get it with reasonable efforts.

You may not impose any further restrictions on the exercise of the rights granted or affirmed under this License. For example, you may not impose a license fee, royalty, or other charge for exercise of rights granted under this License, and you may not initiate litigation (including a cross-claim or counterclaim in a lawsuit) alleging that any patent claim is infringed by making, using, selling, offering for sale, or importing the Program or any portion of it.

## 12. Patents.

A “contributor” is a copyright holder who authorizes use under this License of the Program or a work on which the Program is based. The work thus licensed is called the contributor's “contributor version”. A contributor's “essential patent claims” are all patent claims owned or controlled by the contributor, whether already acquired or hereafter acquired, that would be infringed by some manner, permitted by this License, of making, using, or selling its contributor version, but do not include claims that would be infringed only as a consequence of further modification of the contributor version. For purposes of this definition, “control” includes the right to grant patent sublicenses in a manner consistent with the requirements of this License.

Each contributor grants you a non-exclusive, worldwide, royalty-free patent license under the contributor's essential patent claims, to make, use, sell, offer for sale, import and otherwise run, modify and propagate the contents of its contributor version.

In the following three paragraphs, a “patent license” is any express agreement or commitment, however denominated, not to enforce a patent (such as an express permission to practice a patent or covenant not to sue for patent infringement). To “grant” such a patent license to a party means to make such an agreement or commitment not to enforce a patent against the party.

If you convey a covered work, knowingly relying on a patent license, and the Corresponding Source of the work is not available for anyone to copy, free of charge and under the terms of this License, through a publicly available network server or other readily accessible means, then you must either (1) cause the Corresponding Source to be so available, or (2) arrange to deprive yourself of the benefit of the patent license for this particular work, or (3) arrange, in a manner consistent with the requirements of this License, to extend the patent license to downstream recipients. “Knowingly relying” means you have actual knowledge that, but for the patent license, your conveying the covered work in a country, or your recipient's use of the covered work in a country, would infringe one or more identifiable patents in that country that you have reason to believe are valid.

If, pursuant to or in connection with a single transaction or arrangement, you convey, or propagate by procuring conveyance of, a covered work, and grant a patent license to some of the parties receiving the covered work authorizing them to use, propagate, modify or convey a specific copy of the covered work, then the patent license you grant is automatically extended to all recipients of the covered work and works based on it.

A patent license is “discriminatory” if it does not include within the scope of its coverage, prohibits the exercise of, or is conditioned on the non-exercise of one or more of the rights that are specifically granted under this License. You may not convey a covered work if you are a party to an arrangement with a third party that is in the business of distributing software, under which you make payment to the third party based on the extent of your activity of conveying the work, and under which the third party grants, to any of the parties who would receive the covered work from you, a discriminatory patent license (a) in connection with copies of the covered work conveyed by you (or copies made from those copies), or (b) primarily for and in connection with specific products or compilations that contain the covered work, unless you entered into that arrangement, or that patent license was granted, prior to 28 March 2007.

Nothing in this License shall be construed as excluding or limiting any implied license or other defenses to infringement that may otherwise be available to you under applicable patent law.

**13. No Surrender of Others' Freedom.**

If conditions are imposed on you (whether by court order, agreement or otherwise) that contradict the conditions of this License, they do not excuse you from the conditions of this License. If you cannot convey a covered work so as to satisfy simultaneously your obligations under this License and any other pertinent obligations, then as a consequence you may not convey it at all. For example, if you agree to terms that obligate you to collect a royalty for further conveying from those to whom you convey the Program, the only way you could satisfy both those terms and this License would be to refrain entirely from conveying the Program.

**14. Use with the GNU Affero General Public License.**

Notwithstanding any other provision of this License, you have permission to link or combine any covered work with a work licensed under version 3 of the GNU Affero General Public License into a single combined work, and to convey the resulting work. The terms of this License will continue to apply to the part which is the covered work, but the special requirements of the GNU Affero General Public License, section 13, concerning interaction through a network will apply to the combination as such.

**15. Revised Versions of this License.**

The Free Software Foundation may publish revised and/or new versions of the GNU General Public License from time to time. Such new versions will be similar in spirit to the present version, but may differ in detail to address new problems or concerns.

Each version is given a distinguishing version number. If the Program specifies that a certain numbered version of the GNU General Public License “or any later version” applies to it, you have the option of following the terms and conditions either of that numbered version or of any later version published by the Free Software Foundation. If the Program does not specify a version number of the GNU General Public License, you may choose any version ever published by the Free Software Foundation.

If the Program specifies that a proxy can decide which future versions of the GNU General Public License can be used, that proxy's public statement of acceptance of a version permanently authorizes you to choose that version for the Program.

Later license versions may give you additional or different permissions. However, no additional obligations are imposed on any author or copyright holder as a result of your choosing to follow a later version.

**16. Disclaimer of Warranty.**

THERE IS NO WARRANTY FOR THE PROGRAM, TO THE EXTENT PERMITTED BY APPLICABLE LAW. EXCEPT WHEN OTHERWISE STATED IN WRITING THE COPYRIGHT HOLDERS AND/OR OTHER PARTIES PROVIDE THE PROGRAM “AS IS” WITHOUT WARRANTY OF ANY KIND, EITHER EXPRESSED OR IMPLIED, INCLUDING, BUT NOT LIMITED TO, THE IMPLIED WARRANTIES OF MERCHANTABILITY AND FITNESS FOR A PARTICULAR PURPOSE. THE ENTIRE RISK AS TO THE QUALITY AND PERFORMANCE OF THE PROGRAM IS WITH YOU. SHOULD THE PROGRAM PROVE DEFECTIVE, YOU ASSUME THE COST OF ALL NECESSARY SERVICING, REPAIR OR CORRECTION.

**17. Limitation of Liability.**

IN NO EVENT UNLESS REQUIRED BY APPLICABLE LAW OR AGREED TO IN WRITING WILL ANY COPYRIGHT HOLDER, OR ANY OTHER PARTY WHO MODIFIES AND/OR CONVEYS THE PROGRAM AS PERMITTED ABOVE, BE LIABLE TO YOU FOR DAMAGES, INCLUDING ANY GENERAL, SPECIAL, INCIDENTAL OR CONSEQUENTIAL DAMAGES ARISING OUT OF THE USE OR INABILITY TO USE THE PROGRAM (INCLUDING BUT NOT LIMITED TO LOSS OF DATA OR DATA BEING RENDERED INACCURATE OR LOSSES SUSTAINED BY YOU OR THIRD PARTIES OR A FAILURE OF THE PROGRAM TO OPERATE WITH ANY OTHER PROGRAMS), EVEN IF SUCH HOLDER OR OTHER PARTY HAS BEEN ADVISED OF THE POSSIBILITY OF SUCH DAMAGES.

**18. Interpretation of Sections 16 and 17.**

If the disclaimer of warranty and limitation of liability provided above cannot be given local legal effect according to their terms, reviewing courts shall apply local law that most closely approximates an absolute waiver of all civil liability in connection with the Program, unless a warranty or assumption of liability accompanies a copy of the Program in return for a fee.

## END OF TERMS AND CONDITIONS

## CE 声明



本设备符合 CE 合规性 B 类标准。

## FCC 声明

## FCC B 类声明



本设备符合 FCC 规则第 15 部分的规定。其运行需满足下面两个条件：

1. 本设备不会产生有害干扰。
2. 本设备必须承受受到的干扰，包括可能导致运行异常的干扰。

**注**

经测试，本设备符合 FCC 规则第 15 部分中针对 B 类数字设备的限制标准。这些限制标准旨在提供合理的保护，以防止在住宅区安装设备时产生有害干扰。本设备会产生、使用并可发出射频能量，如果不按说明安装和使用，可能会对无线电通信产生有害干扰。但是，并不保证在特定安装中不会产生此类干扰。如果本设备确实对收音机或电视机接收造成有害干扰（可通过打开和关闭本设备来判定），建议用户尝试采取下列一项或多项措施来消除干扰：

- 改变接收天线的方向或位置。
- 增加本设备与接收设备之间的间距。
- 将本设备与接收设备分别接入不同回路的电源插座。
- 请咨询经销商或经验丰富的收音机/电视机技术人员以寻求帮助。

**重要**

若未经 QNAP Systems, Inc. 批准对本设备进行改动，可能会导致用户失去 FCC 授予的操作本设备的资格。

## VCCI 公告



VCCI-B

**BSMI 公告****SJ/T 11364-2006**

本产品符合中国 RoHS 标准。以下表格标示此产品中某有毒物质的含量符合中国 RoHS 标准规定的限量要求。

本产品上会附有“环境友好使用期限”的标签，此期限是估算这些物质“不会有泄漏或突变”的年限。本产品可能包含有较短的环境友好使用期限的可替换元件，像是电池或灯管，这些元件将会单独标示出来。

部件名称	有毒有害物质或元素					
	铅 (Pb)	汞 (Hg)	镉 (Cd)	六价铬 (CR(VI))	多溴联苯 (PBB)	多溴二苯醚 (PBDE)
壳体	0	0	0	0	0	0
显示	0	0	0	0	0	0
印刷电路板	0	0	0	0	0	0
金属螺帽	0	0	0	0	0	0
电缆组装	0	0	0	0	0	0
风扇组装	0	0	0	0	0	0
电力供应组装	0	0	0	0	0	0
电池	0	0	0	0	0	0
O: 表示该有毒有害物质在该部件所有物质材料中的含量均在 SJ/T11363-2006 标准规定的限量要求以下。						
X: 表示该有毒有害物质至少在该部件的某一均质材料中的含量超出 SJ/T11363-2006 标准规定的限量要求。						

## 欧盟指令 2002/96/EC 废弃电子电气设备 (WEEE)



根据 WEEE 法规的要求，向所有受 WEEE 指令约束的 QNAP 品牌电子产品提供以下用户信息。

产品或其包装上的此标志表示该产品不得与其他生活垃圾一起处理。相反，您有责任将废弃设备移交给指定的回收废弃电气和电子设备的回收点，来处置废弃设备。在处置时对废弃设备进行单独收集和回收，将有助于保护自然资源，并确保以保护人类健康和环境的方式进行回收。有关废弃设备回收点位置的更多信息，请联系您当地的市政府、生活垃圾处理服务或购买产品的商店。

## EU RoHS 声明

本设备符合关于限制在电子电器设备中使用某些有害成分的欧盟 RoHS 指令 2011/65/EU。该指令适用于在电子电器设备中使用铅、汞、镉、六价铬、多溴联苯 (PBB) 和多溴联苯醚 (PBDE)。

## 激光合规声明

确保光纤小型可插拔 (SFP) 模块符合 CNS 15016-2 或 IEC 60852-1 认证和 1 类激光规范。

使用光纖可插拔 (SFP) 模組時，請確保它通過了 CNS 15016-2 或 IEC 60825-1 認證和 1 類激光產品。

## UKCA 声明



此设备符合在英国销售产品的 UKCA 要求。