



QNAP

QSW-M2106

QSW-M2106R

使用手冊

目錄

1. 產品概觀	
關於 QSW-M2106R.....	3
硬體規格.....	3
包裝內容.....	4
元件.....	4
前面板.....	4
前面板 LED 燈.....	5
安全資訊.....	5
2. 安裝與存取	
安裝需求.....	7
設定交換器.....	7
裝上橡膠腳座.....	7
把手安裝.....	9
將交換器連接至電腦或網路.....	10
將交換器連接至電腦.....	10
將交換器連接至網路.....	11
交換器存取.....	12
使用瀏覽器存取交換器.....	12
透過 Qfinder Pro 存取交換器.....	13
3. 基本操作	
LED 燈號.....	14
重設按鈕.....	15
4. QSS	
關於 QSS.....	16
開始使用.....	16
網路管理.....	16
編輯連接埠設定.....	16
新增 VLAN.....	17
新增連結彙總群組 (LAG).....	17
管理快速跨距樹狀目錄通訊協定 (RSTP) 設定.....	18
編輯 LLDP 設定.....	19
新增靜態 MAC 位址.....	19
設置 IGMP Snooping.....	20
編輯 QoS 設定.....	20
管理存取控制清單 (ACL) 項目.....	21
刪除網路設定.....	23
監視網路設定.....	23
系統管理.....	24
系統設定.....	24
韌體更新.....	28
5. 支援和其他資源	
6. 詞彙	
myQNAPcloud.....	33
Qfinder Pro.....	33
QSS.....	33

QuNetSwitch.....	33
------------------	----

7. 聲明

有限保固.....	34
免責聲明.....	34
GNU Public License.....	34
CE 聲明.....	42
FCC 聲明.....	42
VCCI 聲明.....	42
BSMI 聲明.....	43
SJ/T 11364-2006.....	43
歐盟廢電子電機設備 (WEEE) 指令 (2002/96/EC).....	44
歐盟 RoHS 聲明.....	44
雷射規範聲明.....	44
UKCA 聲明.....	44

1. 產品概觀

本章介紹 QNAP 裝置的基本資訊。

關於 QSW-M2106R

QSW-M2106R 是一款數千兆位元的乙太網路交換器，提供第 2 層網路管理功能。此交換器配備六個 2.5 GbE RJ45 連接埠、兩個 10 GbE RJ45 連接埠，以及兩個 10 GbE SFP+ 複合埠，提升網路擴充能力及營運生產力。透過 RJ45 主控台連接埠存取交換器，可進行有效率的裝置管理和交換器操作。

硬體規格



警告

如果您的 QNAP 產品有硬體瑕疵，請將產品寄回 QNAP 或 QNAP 授權服務中心進行維修或換貨。只要您或未經授權的第三方嘗試修復產品或執行產品維修流程，皆會導致產品保固失效。

對於因未獲授權進行修改或安裝不支援之第三方應用程式所導致的任何損害或資料遺失，QNAP 一概不予負責。

如需詳細資訊，請參見：[QNAP 產品保固服務條款](#)。



提示

型號規格如有變更，恕不另行通知。若要查看最新規格，請前往：<https://www.qnap.com>。

訂購料號	CPU	記憶體
QSW-M2106R-2S2T	Marvell® Prestera® 98DX2528	1 GB

元件	QSW-M2106R-2S2T
處理器	
CPU	Marvell® Prestera® 98DX2528
頻率	雙核心
架構	ARM 32 位元
晶片組	Marvell® Prestera® 98DX2528
網路介面	<ul style="list-style-type: none"> • 6 x 100M/1G/2.5G RJ45 連接埠 • 2 x 100M/1G/2.5G/5G/10G GbE RJ45 連接埠 • 2 x 1G/10G SFP+ 複合埠
管理介面	1 x RJ45 console port
總耗電量	40W
介面	
按鈕	交換器重設
LED 燈號	
系統	狀態
連接埠	<ul style="list-style-type: none"> • 速度 • 活動
尺寸	
外型	精簡式

元件	QSW-M2106R-2S2T
尺寸 (高 x 寬 x 深)	43.3 x 207 x 248.8 mm (1.70 x 8.14 x 9.79 in)
淨重	1.55 kg (3.41 lbs)
其他	
電源供應器	100-240V、50/60 Hz
操作溫度	0°C 至 40°C (32°F 至 104°F)
相對濕度	<ul style="list-style-type: none"> 不凝結相對溼度：5% 至 95% 濕球溫度：27°C (80.6°F)

包裝內容

項目	數量
QSW-M2106R	1
電源線	1
滑軌支架	2
滑軌支架螺絲	6
橡膠腳座	4
快速安裝手冊 (QIG)	1

元件

前面板

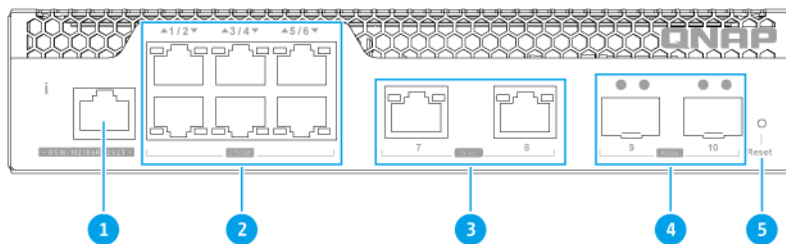

編號	元件	編號	元件
1	RJ45 主控台連接埠	4	10GbE SFP+ 連接埠
2	2.5GbE RJ45 連接埠	5	交換器重設按鈕
3	10GbE RJ45 連接埠	-	-

前面板 LED 燈

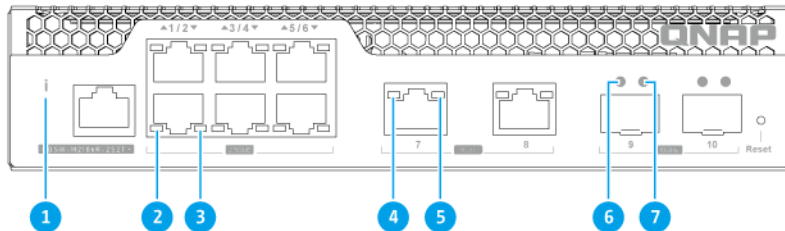

編號	元件	編號	元件
1	交換器狀態 LED 燈	5	10GbE RJ45 (5G/2.5G/1G/100M 速度) LED
2	2.5GbE RJ45 (2.5G 速度) LED	6	10GbE SFP+ (10G 速度) LED
3	2.5GbE RJ45 (1G/100M 速度) LED	7	10GbE SFP+ (1G 速度) LED
4	10GbE RJ45 (10G 速度) LED	-	-

安全資訊

以下指示幫助確保人身安全及環境安全。執行任何操作前，請仔細閱讀本安全指示。

一般指示

- 裝置應放置在實施進出管制的場所，控管方式包括工具、鎖鑰或其他安全機制。
- 唯有具技能且獲得授權的合格裝置管理員能夠存取裝置；合格裝置管理員必須熟悉所有管制方法、安全注意事項、安裝及保養程序。
- 為避免受傷或元件損壞，在觸碰硬碟及其他內部系統元件前，請先確認其是否已經冷卻。
- 請遵守靜電放電 (ESD) 程序以防止潛在傷害或元件損壞。

電源

- 為了降低走火或觸電風險，務必只將電源線連接至正確接地的電源插座。
- 為防止嚴重傷害事故發生，在安裝或更換系統元件前，經訓練的維修技術人員必須先從裝置上拔除所有電源供應器的電源線。

系統電池

- 本產品包含鈕扣電池。
- 如果吞下鈕扣型鋰電池可能會在 2 小時內造成嚴重或致命的傷害。

- 請將電池放在兒童接觸不到的地方。
- 如果您認為電池可能已被吞下或位於身體的任何部位，請立即就醫。
- 更換電池時，請務必使用相同類型的電池，以免電池爆炸造成受傷或使元件損壞。
- 請遵照當地法規或電池製造商的指示妥善處置廢棄電池。

移動的零件

-



轉動的風扇葉片：裝置連接至電源時，請使身體部位遠離正在轉動的風扇葉片。

-



移動的元件：使身體部位遠離正在移動的其他元件。

- 該裝置不適合在兒童可能出現的地方使用。

2. 安裝與存取

本章說明特定硬體安裝與交換器存取步驟。

安裝需求

類別	項目
環境	<ul style="list-style-type: none"> • 室溫：0°C 至 40°C (32°F 至 104°F) • 不凝結相對溼度：5% to 95% • 濕球溫度：27°C (80.6°F) • 平坦且防靜電的表面，不受陽光直射，亦不與液體或化學物質接觸 • 確認沒有物體會阻礙交換器的通風口，或者對交換器或電源線產生壓力。
硬體和週邊設備	<ul style="list-style-type: none"> • 電腦或 NAS • 網路線
工具	<ul style="list-style-type: none"> • 1 號或 2 號十字螺絲起子 • 平頭螺絲起子 • 防靜電腕帶

設定交換器

1. 將交換器置於符合需求的環境。
如需詳細資訊，請參見：[安裝需求](#)。
2. 打開交換器電源。
3. 連接交換器至電腦或網路。
如需詳細資訊，請參見：[將交換器連接至電腦](#)。
4. 登入 QSS。

裝上橡膠腳座

1. 關閉裝置電源。
2. 從電源插座拔下電源線。
3. 中斷所有連接線和外接裝置的連線。
4. 將裝置上下翻轉。

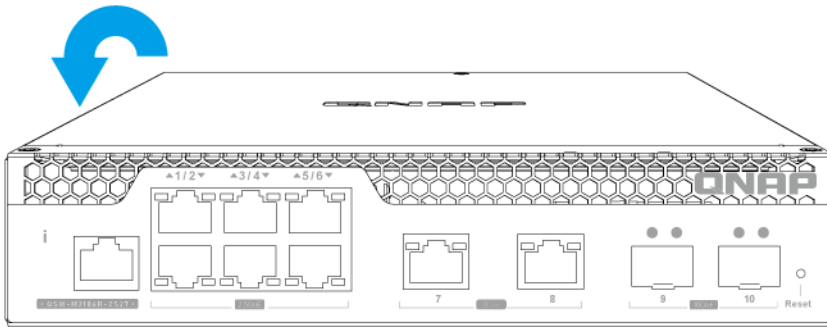

5. 裝上橡膠腳座。

- a. 將橡膠腳座的保護膜取下。
- b. 裝上橡膠腳座。

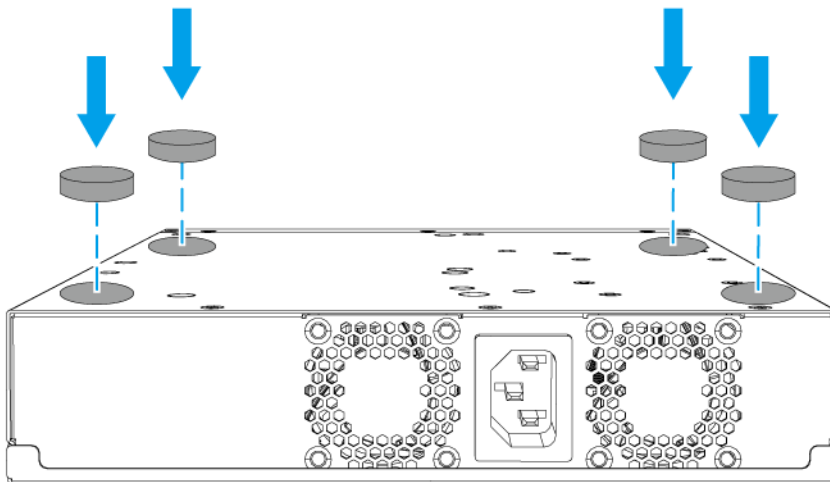

- c. 將裝置正常直立。

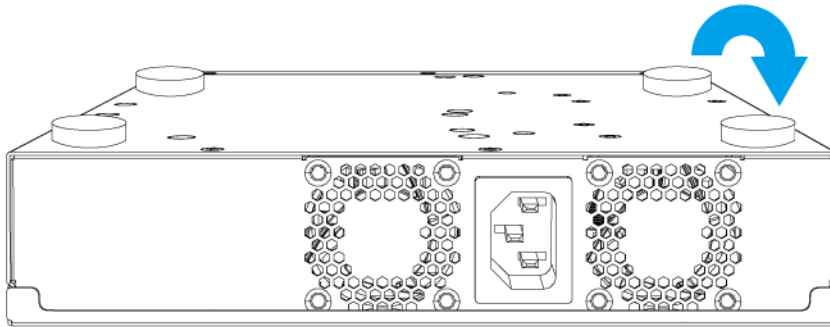

6. 連上所有連接線和外接裝置。
7. 將電源線連接至電源插座。
8. 開啟裝置電源。

把手安裝

安裝把手即可輕鬆且穩固地拿取機架上的裝置。

1. 關閉裝置電源。
2. 從電源插座拔下電源線。
3. 中斷所有連接線和外接裝置的連線。
4. 將把手安裝到角形托座上。
 - a. 將把手開口對齊至角形托座上的兩個圓頭螺絲洞。
 - b. 鎖上螺絲，將把手鎖定在角形托座上。

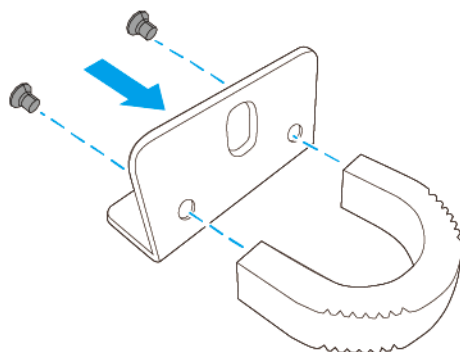

5. 在裝置上安裝角形托座。
 - a. 將角形托座上的孔洞對齊機殼上的孔洞。



注意

請確定把手與前面板面對相同的方向。

- b. 鎖上螺絲，將角形托座鎖定在機殼上。

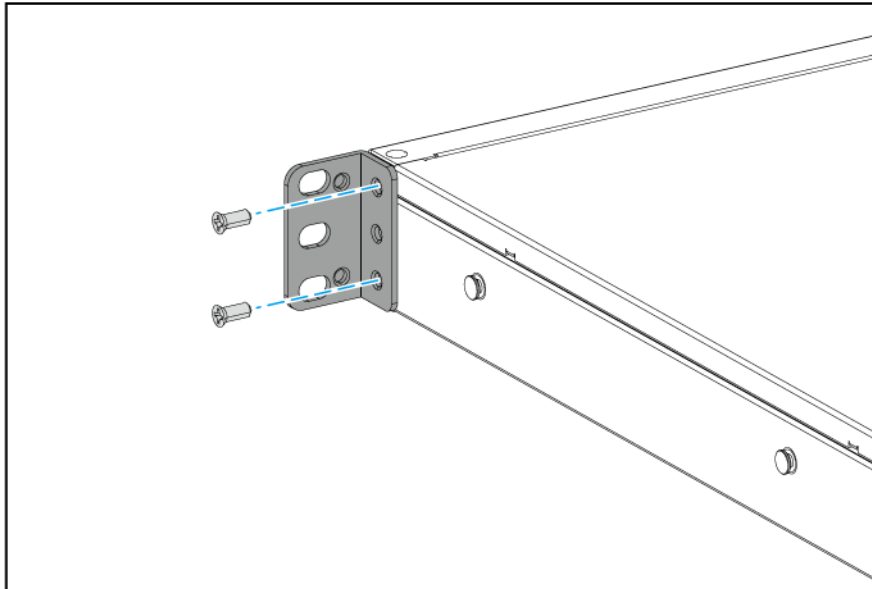

6. 在機殼的另一側安裝第二個把手。
7. 連上所有連接線和外接裝置。
8. 將電源線連接至電源插座。
9. 開啟裝置電源。

將交換器連接至電腦或網路

您可將交換器連接至電腦或區域網路。如需詳細資訊，請參見下列主題：

- [將交換器連接至電腦](#)
- [將交換器連接至網路](#)

將交換器連接至電腦

您可透過將網路線連接至交換器上的 PoE 連接埠或主機連接埠，將交換器連接至 QNAP NAS，來擴充儲存容量並將資料備份至另一台 NAS。但是您必須將交換器連接至電腦來編輯設定。

1. 打開交換器電源。
2. 將交換器連接至電腦。
 - a. 將網路線連接至交換器上的主機連接埠。
 - b. 將網路線連接至電腦上的 Gigabit 網路連接埠。

- c. 選擇性: 將交換器連接至 NAS。

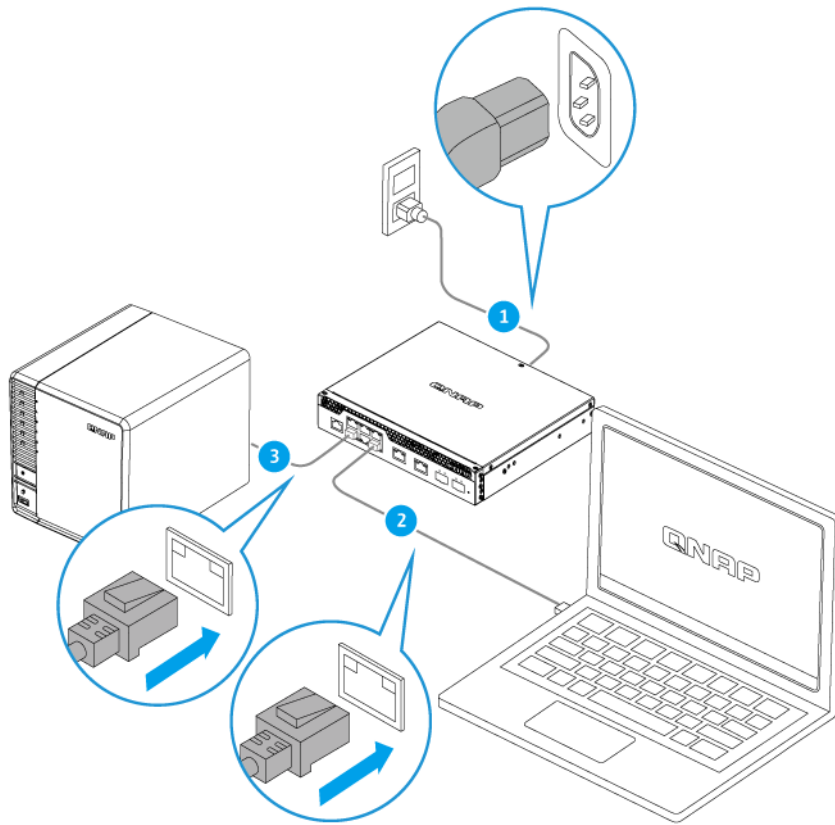

3. 確認電腦可辨識交換器。
- a. 在主機電腦中開啟 Qfinder Pro。



注意

若要下載 Qfinder Pro，請前往：<https://www.qnap.com/utilities>。

- b. 從清單中尋找交換器。

將交換器連接至網路

您可透過主機連接埠或 PoE 連接埠來連接至區域網路。

1. 打開交換器電源。
2. 利用主機連接埠，將交換器連接至區域網路。
3. 在連接相同區域網路的電腦上執行 Qfinder Pro。



注意

若要下載 Qfinder Pro，請前往：<https://www.qnap.com/utilities>。

4. 在清單中找到交換器，然後在名稱或 IP 位址上按兩下。
QSS 登入畫面隨即出現。
5. 輸入 QSS 登入資訊。

6. 按一下 [登入] 。

交換器存取

方式	說明	需求
網頁瀏覽器	<p>如果具備下列資訊，就可以使用相同網路內的任何電腦存取交換器：</p> <ul style="list-style-type: none"> • 交換器名稱（例如：http://example123/）或 IP 位址 • 登入有效使用者帳戶的認證資料 <p>如需詳細資料，請參見：使用瀏覽器存取交換器。</p>	<ul style="list-style-type: none"> • 與交換器連接相同網路的電腦 • 網頁瀏覽器
Qfinder Pro	<p>Qfinder Pro 是一款桌面應用工具，可讓使用者定位和存取特定網路內的 QNAP 裝置。此應用工具支援 Windows、macOS、Linux 及 Chrome OS。</p> <p>如需詳細資訊，請參見：透過 Qfinder Pro 存取交換器。</p>	<ul style="list-style-type: none"> • 與交換器連接相同網路的電腦 • 網頁瀏覽器 • Qfinder Pro

使用瀏覽器存取交換器

如果您知道交換器的 IP 位址以及有效使用者帳戶的登入認證資料，就可以從網路上的任何電腦來存取交換器。QNAP 交換器預設支援 DHCP 客戶端設定進行 IP 分配。連線至網路時，交換器將自動保留來自 DHCP 伺服器的 IP 位址。



注意

- 如果您不知道交換器的 IP 位址，則可使用 Qfinder Pro 來尋找交換器。
- 如果交換器未連接 DHCP 支援的網路，則可以透過將電腦的 IP 地址更改為 169.254.100.102 來存取交換器網頁界面。
- 交換器的預設 IP 位址為 169.254.100.101。

1. 請確認您的電腦與交換器連線到相同的網路。
2. 開啟電腦的網頁瀏覽器。
3. 在網址列中輸入交換器的 IP 位址。
QSS 登入畫面隨即顯示。
4. 指定預設使用者名稱與密碼。

預設使用者名稱	預設密碼
admin	<p>交換器映像的 MAC 位址，請刪去所有標點符號，並將所有字母大寫。</p> <p> 提示 例如，如果 MAC 位址為 00:0a:0b:0c:00:01，預設密碼則為 000A0B0C0001。 您可以透過 Qfinder Pro 找到 MAC 位址，也可在裝置上的貼紙找到「MAC」字樣。</p> <p> 注意 系統將會提示您在首次登入後更改密碼。 出於安全考慮，QNAP 強烈建議您在首次登入後更改密碼。</p>

5. 按一下 [登入]。

QSS 桌面隨即顯示。



重要

在設定交換器後，確保將電腦的 IP 地址更改為原始設定。

透過 Qfinder Pro 存取交換器

1. 在與交換器連接到相同網路的電腦上安裝 Qfinder Pro。



提示

若要下載 Qfinder Pro，請前往：<https://www.qnap.com/en/utilities>。

2. 開啟 Qfinder Pro。
Qfinder Pro 會自動搜尋網路內的所有 QNAP 裝置。
3. 在清單中找到交換器，然後在名稱或 IP 位址上按兩下。
QSS 登入畫面隨即在預設網頁瀏覽器中開啟。
4. 指定預設使用者名稱與密碼。

預設使用者名稱	預設密碼
admin	<p>交換器映像的 MAC 位址，請刪去所有標點符號，並將所有字母大寫。</p> <p> 提示 例如，如果 MAC 位址為 00:0a:0b:0c:00:01，預設密碼則為 000A0B0C0001。 您可以透過 Qfinder Pro 找到 MAC 位址，也可在裝置上的貼紙找到「MAC」字樣。</p>

5. 按一下 [登入]。

QSS 桌面隨即顯示。

3. 基本操作

本章介紹交換器的基本操作。

LED 燈號

LED 燈號指示交換器開機時的系統狀態與相關資訊。下列 LED 燈號資訊僅適用於交換器已連接至網路的情況。

如需 LED 燈號的位置資訊，請參見：[前面板 LED 燈](#)。

LED	狀態	說明
系統狀態	綠燈	裝置就緒。
	綠燈閃爍	<ul style="list-style-type: none"> 裝置正在初始化。 韌體正在更新。 <div style="border-left: 2px solid #0070C0; padding-left: 10px; margin-top: 10px;"> <p>注意 請勿在韌體更新期間拔下電源線或 USB 連接線，也不要強制結束應用程式。</p> </div> <ul style="list-style-type: none"> 裝置正在重設中。
	紅燈	裝置發生嚴重錯誤。
	熄滅	裝置已關機。
2.5GbE RJ45 (2.5G 速度)	綠燈	連線速度為 2.5Gbps。
	綠燈閃爍	資料傳送中。
	熄滅	無網路連線。
2.5GbE RJ45 (1G/100M/10M 速度)	橙燈	連線速度為 1Gbps 或 100Gbps。
	橙燈閃爍	資料傳送中。
	熄滅	無網路連線。
10GbE RJ45 (10G 速度)	綠燈	連線速度為 10Gbps。
	綠燈閃爍	資料傳送中。
	熄滅	無網路連線。
10GbE RJ45 (5G/ 2.5G/1G/100M 速度)	橙燈	連線速度為 5Gbps、2.5Gbps、1Gbps 或 100Mbps。
	橙燈閃爍	資料傳送中。
	熄滅	無網路連線。
10GbE SFP+ (10G 速度)	綠燈	連線速度為 10Gbps。
	綠燈閃爍	資料傳送中。
	熄滅	無網路連線。
10GbE SFP+ (1G 速度)	橙燈	連線速度為 1Gbps。
	橙燈閃爍	資料傳送中。
	熄滅	無網路連線。

重設按鈕

操作	使用者操作	結果
系統基本重設	按住按鈕 5 秒。	<p>以下設定將回復至預設值：</p> <ul style="list-style-type: none"> 系統管理員密碼：預設密碼為第一個 MAC 位址（不包含特殊字元）。例如，若第一個 MAC 位址為 00-08-9B-F6-15-75，則 admin 密碼為 00089BF61575。 <p> 注意 您可以透過 Qfinder Pro 或者裝置標籤上列為 MAC1 處找到第一個 MAC 地址。</p> <ul style="list-style-type: none"> 系統會自動啟用 admin 帳戶
系統進階重設	按住按鈕 10 秒。	回復為出廠預設值。

4. QSS

關於 QSS

QNAP 交換器系統 (QSS) 是 QNAP 交換器裝置的網路管理作業系統。QSS 允許進行交換器的第 2 層網路管理和系統管理。

開始使用

1. 請以管理員身分登入交換器。
預設管理員帳戶為 `admin`。
如需詳細資訊，請參見：[交換器存取](#)。
2. 編輯系統設定。
如需詳細資訊，請參見：[系統設定](#)。
3. 編輯連接埠設定和其他網路設定。
如需詳細資訊，請參見：[網路管理](#)。

網路管理

交換器的基本網路設置包括連接埠管理、VLAN 設置、各種通訊協定的設置，以及透過服務品質 (QoS) 和存取控制清單 (ACL) 的流量管理。

儀表板

儀表板會於介面使用者的設置區域開啟。按一下儀表板中的下拉式選單，即可檢視所有連接埠的連接埠狀態、VLAN 狀態、連結彙總狀態以及連接埠流量。

您也可以刪除使用者編輯的網路設定，並監視交換器的網路設定。

編輯連接埠設定

1. 登入 QSS。
2. 前往 **[設定]** > **[連接埠管理]**。
3. 前往 **[連接埠設定]**。
4. 識別連接埠。
5. 編輯設定。

設定	說明
狀態	控制連接埠的運行模式
速度	指定連接埠運行的最大速度。
流量控制	控制連接埠的流量控制狀態  重要 當連接埠速度設定為 HDX 時，不支援「流量控制」。

6. 按一下 **[儲存]**。

QSS 隨即儲存設定。

新增 VLAN

虛擬 LAN (VLAN) 隨即將多個網路裝置群組在一起，並限制其廣播網域。VLAN 的各成員間會互相隔離，且網路流量只會在群組成員間互相傳送。

每個 VLAN 會被指派特定的 VLAN 識別碼。**VLAN** 畫面會顯示現有 VLAN 的相關資訊，並提供 VLAN 設置選項的存取權。

1. 登入 QSS。
2. 前往 **[設定]** > **[VLAN]**。
3. 按一下 **[新增]**。
[新增 VLAN] 視窗隨即開啟。
4. 指定 VLAN ID。
5. 選擇要納入 VLAN 的連接埠。
只有標出的連接埠可屬於多個 VLAN。
6. 按一下 **[儲存]**。

QSS 隨即新增 VLAN。

新增連結彙總群組 (LAG)

連結彙總控制通訊協定 (LACP) 可讓您將多個網路介面卡結合成單一邏輯網路介面。這可確保提高輸送量並提供備援。如果發生連接埠故障，流量會經由剩下的連接埠繼續執行。

連結彙總 頁面會顯示現有連結彙總群組的相關資訊，並提供設置選項的存取權。



警告

若要避免 LAG 組態過程期間發生網路迴圈錯誤，在所有裝置設定 LAG 之後，請勿使用多條網路纜線把交換器連接到其他裝置。您可以啟用迴圈防護，以避免連線網路中的網路迴圈。

1. 登入 QSS。
2. 前往 **[設定]** > **[連結彙總]**。
3. 識別群組。
4. 按一下 。
[編輯群組] 視窗隨即開啟。
5. 編輯群組設定。

設定	說明
模式	控制群組的連結彙總模式 <ul style="list-style-type: none"> • LACP：提供自動容錯移轉和動態設定 • 靜態：在選擇的連結彙總連接埠一次彙總所有設定 <div style="display: flex; align-items: flex-start;">  <div> <p>重要</p> <p>將網路線連接到交換器前，請先啟用連結彙總，以避免資料迴圈。</p> </div> </div>

設定	說明
連接埠設定	指定哪些連接埠要納入至群組  注意 請務必為 LAG 的所有成員連接埠配置相同的設定。

- 按一下 **【儲存】**。

QSS 隨即更新該群組設定。



注意

將 LAG 指派給 VLAN 時，QNAP 建議您從 VLAN 中移除個別 LAG 連接埠成員，然後視需要將整個群組新增至 VLAN。如果未移除個別連接埠成員，VLAN 會重設為其預設設定。

管理快速跨距樹狀目錄通訊協定 (RSTP) 設定

RSTP 提供跨距樹狀目錄的快速聚合，組建交換器網路的無迴圈拓撲。當使用中的連結失敗時，RSTP 允許您啟用備份連結。



注意

- RSTP 預設為停用。
- 交換器的預設橋接優先順序為 32768。

編輯 RSTP 設定

- 登入 QSS。
- 前往 **【設定】** > **【RSTP】**。
- 變更 RSTP 控制狀態。

切換設定	說明
	按一下以啟用 RSTP 功能。
	按一下以停用 RSTP 功能。

- 按一下 **【儲存】**。

QSS 隨即儲存設定。

設定橋接器優先順序

您可以在 RSTP 設置欄位中設置交換器的 RSTP 橋接優先順序。

- 登入 QSS。
- 前往 **【設定】** > **【RSTP】** > **【RSTP 設定】**。
- 啟用 RSTP。



注意

如需詳細資訊，請參見：[編輯 RSTP 設定](#)。

- 從下拉式清單選擇 RSTP 橋接器優先順序。

**注意**

預設優先順序為 32768，建議您將根橋接器優先順序設定為 0。

5. 按一下 **[儲存]**。

QSS 隨即更新 RSTP 橋接器優先順序

編輯 LLDP 設定

連結層探索通訊協定 (LLDP) 會使用定期廣播，將裝置資訊通告給整個網路，並探索相鄰的裝置。此通訊協定的運作方式是建立分佈式資料庫，並從通過網路連結的相鄰連接埠來收集資訊。

LLDP 頁面會針對偵測到的裝置顯示相關資訊，並允許您啟用或者停用 LLDP。

1. 登入 QSS。
2. 前往 **[設定]** > **[LLDP]**。
3. 變更 LLDP 控制狀態。

切換設定	使用者操作
	按一下以啟用 LLDP 功能。
	按一下以停用 LLDP 功能。

4. 按一下 **[儲存]**。

QSS 隨即儲存設定。

新增靜態 MAC 位址

MAC 位址表用以追蹤 MAC 位址，並透過特定通訊埠來轉送相關的單點傳播流量。

1. 登入 QSS。
2. 前往 **[設定]** > **[LLDP]** > **[MAC 位址表]**。
3. 指定 MAC 位址表的留存時間。

**注意**

您可以設定項目保留在 MAC 位址表中的時間長度。

4. 按一下 **[新增]**。
[新增靜態 MAC 位址] 視窗隨即開啟。
5. 編輯 MAC 位址設定。
 - a. 指定 VLAN ID。
 - b. 指定 MAC 位址。
 - c. 選擇至少一個連接埠。
6. 按一下 **[儲存]**。
[新增靜態 MAC 位址] 視窗隨即關閉。

QSS 隨即新增 MAC 位址。

設置 IGMP Snooping

網際網路群體管理協定 (IGMP) 可管理 IP 多點傳播群組的成員資格。IP 主機和相鄰的多點傳送路由器使用 IGMP 建立多點傳送群組成員身份。

IGMP Snooping 頁面會針對偵測到的 IGMP 群組顯示相關資訊，並提供對於 IGMP snooping 設置選項的存取權。

1. 登入 QSS。
2. 前往 **[設定]** > **[IGMP Snooping]**。
3. 按一下 。
QSS 隨即啟用 IGMP Snooping。
4. 編輯 IGMP snooping 設定。

設定	說明
多點傳播泛濫封鎖	封鎖來自不明來源的多點傳播泛濫
路由器連接埠	指定要將哪些連接埠當成 VLAN 的路由器連接埠 接收 IGMP 封包後，QSS 將會透過選定的路由器連接埠轉送流量。
快速離開	指定支援 IGMP v2 「快速離開」功能的連接埠 接收 IGMP 離開訊息後，QSS 會停止將多點傳送流量轉送至選取的「快速離開」連接埠。

5. 按一下 **[儲存]**。

QSS 隨即儲存 IGMP snooping 設定。

編輯 QoS 設定

服務品質 (QoS) 可對不同的網路裝置及封包進行分類並決定優先順序，以改善網路流量的分配。您可以透過 QoS 設定流量原則，並在交換器連接埠上啟用這些原則。

若要變更連接埠的 QoS 優先順序，請前往 **[設定]** > **[QoS]**，指派介於 0 到 7 之間的優先順序值，然後按一下 **[儲存]**。



注意

- QSS 支援從 0 到 7 的八種優先順序佇列設定，其中 0 是最低優先順序，7 是最高優先順序。指派最高優先順序的連接埠將允許最先傳送資料。
- 您可以同時停用 CoS 和 DSCP 偵測設定，但無法同時啟用這些設定。
- 在預設情況下，加權循環配置資源 (WRR) 會套用為預設的 QoS 排程機制。佇列的權重與從佇列送出封包數成正比。WRR 可防止低優先順序佇列中的封包未提供服務，並確保交換器會優先傳輸延遲敏感性封包。

設置 QoS 的 CoS 優先順序

CoS (服務類別) 是框架乙太網路標頭中的 3 位元欄位。CoS 值會根據 CoS 值 (0-7) 決定將流量轉送至哪個佇列。

1. 登入 QSS。
2. 前往 **[設定]** > **[QoS]**。

3. 識別連接埠。
4. 按一下 [CoS 檢查] 下的 。
QSS 會在連接埠上啟用 CoS 檢查。
5. 按一下 [編輯 CoS 檢查]。
6. 在 1 到 8 之間指定 CoS 優先順序值。
7. 按一下 [儲存]。
QSS 會更新 CoS 值的優先順序佇列。
8. 按一下 [儲存]。

QSS 會更新 QoS 資訊。

設置 QoS 的 DSCP 優先順序

DSCP (區別服務代碼點) 是封包 IP 標頭中的 6 位元欄位，用來分類封包。DSCP 值會根據指派給 DSCP 值 (0-63) 的優先順序決定將封包轉送至某個佇列。

1. 登入 QSS。
2. 前往 [設定] > [QoS]。
3. 找出連接埠。
4. 按一下 [DSCP 檢查] 下的 。
QSS 會在連接埠啟用 DSCP 檢查。
5. 按一下 [編輯 DSCP 檢查]。
6. 在 1 到 8 之間指定 DSCP 優先順序值。
7. 按一下 [儲存]。
QSS 會更新 DSCP 值的優先順序佇列。
8. 按一下 [儲存]。

QSS 會更新 QoS 資訊。

管理存取控制清單 (ACL) 項目

存取控制清單可透過使用受控的規則集來處理交換器的網路流量。每個 ACL 規則都專用於一組使用者建立的條件，資料封包必須滿足該條件才能符合規則。資料封包在沒有可相符的 ACL 規則的情況下，交換器會套用預設規則。或者，交換器會比對資料封包與規則，以便允許或拒絕封包。

您可以利用 ACL 控制主機對於網路不同部分的存取，或在交換器層級上控制流量的轉送或封鎖。

新增基於 IP 位址的 ACL 規則

1. 登入 QSS。
2. 前往 [設定] > [ACL] > [依 IP 位址]。
3. 按一下 [新增]。
[新增 ACL - IP 位址] 視窗隨即開啟。

4. 編輯 ACL 設定。

設定	使用者操作
ACL 號碼	指定介於 1 到 255 之間的數字。
來源	
IP 位址	指定來源 IP 位址。
子網路遮罩	指定來源子網路遮罩。
目的地	
IP 位址	指定目的地 IP 位址。
子網路遮罩	指定目的地子網路遮罩。
連接埠	選取要套用 ACL 規則的特定通訊埠，或選擇 [全部] 將規則套用至所有連接埠。
權限	選擇下列其中一個選項： <ul style="list-style-type: none"> • 允許 • 拒絕

5. 按一下 **[儲存]**。

QSS 隨即新增 IP 位址的 ACL 規則。

新增基於 MAC 位址的 ACL 規則

1. 登入 QSS。
2. 前往 **[設定]** > **[ACL]** > **[依 MAC 位址]**。
3. 按一下 **[新增]**。
[新增 ACL—MAC 位址] 視窗隨即開啟。
4. 編輯 ACL 設定。

設定	使用者操作
ACL 號碼	指定介於 1 到 255 之間的數字。
來源	
MAC 位址	指定來源 MAC 位址。
目的地	
MAC 位址	指定目的地 MAC 位址。
連接埠	選取要套用 ACL 規則的特定通訊埠，或選擇 [全部] 將規則套用至所有連接埠。
權限	選擇下列其中一個選項： <ul style="list-style-type: none"> • 允許 • 拒絕

5. 按一下 **[儲存]**。

QSS 將會新增基於 MAC 位址的 ACL 規則。

刪除網路設定

1. 登入 QSS。
2. 前往 **[設定]**。
3. 選取網路設定。



注意

刪除網路設定僅適用於 ACL 規則、連結彙總群組、靜態 MAC 位址和 VLAN。

4. 按一下 。
確認訊息隨即顯示。
5. 按一下 **[刪除]**。



QSS 隨即刪除網路設定。

監視網路設定

您可以在 **[設定]** 區段監視下列網路設定。這些設定可用來監視和診斷交換器作業。

1. 登入 QSS。
2. 前往 **[設定]**。
3. 選取網路設定。

設定	說明
IGMP Snooping 統計資料	前往 [IGMP Snooping] > [IGMP Snooping 統計資料] 。 針對偵測到的 IGMP 群組顯示相關統計資訊。
LLDP 遠端裝置	前往 [LLDP] > [LLDP 遠端裝置] 。 顯示啟用的 LLDP 連接埠資訊，包括系統功能及遠端管理 IP 位址。 可能的系統功能包括： <ul style="list-style-type: none"> • 橋接器 • DOCSIS 纜線裝置 • 中繼器 • 已保留 • 路由器 • 僅限站台 • 電話 • WLAN 存取點 • 其他

設定	說明
連接埠狀態	<p>前往 [連接埠管理] > [連接埠狀態] 以檢視下列連接埠狀態資訊：</p> <ul style="list-style-type: none"> • 連接埠號碼 • 連接埠連結狀態 • 連接埠狀態 • 連接埠速度 • 流量控制
連接埠統計資料	<p>a. 前往 [連接埠管理] > [連接埠統計資料] 以檢視網路的連接埠統計資料。</p> <p>b.  按一下  可將檢視選項變更為清單檢視。</p>



系統管理

[系統] 區段提供存取裝置的設定選項。

系統設定

[系統設定] 選單包含系統設定選項，例如交換器的系統資訊、IP 資訊、密碼設定、安全連線設定以及時間設定。

變更交換器名稱

1. 登入 QSS。
2. 前往 **[系統]** > **[系統設定]** > **[系統資訊]**。
3. 按一下 。
4. 指定交換器名稱。
必備條件：
 - 長度：1-14 個字元
 - 有效字元：A-Z、a-z、0-9
 - 有效特殊字元：連字號 (-)
5.  按一下  以確認交換器名稱。

QSS 將會更新交換器名稱。

設定交換器 IP 資訊

1. 登入 QSS。
2. 前往 **[系統]** > **[系統設定]** > **[IP]**。
3. 選取網路設置設定。

設定	說明
自動取得 IP 與 DNS	如果網路支援 DHCP，介面卡會自動取得 IP 位址和網路設定。
手動設定 IP 與 DNS	<p>手動指定固定 IP 位址。您必須設定下列資訊：</p> <ul style="list-style-type: none"> • 固定 IP 位址 • 子網路遮罩 • 預設閘道 <p> 注意 交換器的預設閘道 IP 位址為選用。</p>

4. 按一下 **[儲存]**。
確認訊息隨即顯示。
5. 按一下 **[是]**。

QSS 隨即更新 IP 資訊。



注意
利用 Qfinder Pro 找到交換器並登入 QSS。

更新交換器密碼

1. 登入 QSS。
2. 前往 **[系統] > [系統設定] > [密碼]**。
3. 設定新密碼。



提示
按一下  可顯示您輸入的密碼。

設定	使用者操作
目前密碼	指定裝置目前密碼。
新密碼	設定長度為 8 到 20 個 ASCII 字元的密碼。
確認新密碼	重新輸入新密碼。

4. 按一下 **[儲存]**。

QSS 會將您登出交換器介面。您可以使用新密碼存取交換器。

編輯時間設定



注意
您必須正確設定時間來確保以下內容：

- 使用網頁瀏覽器連線裝置或儲存檔案時，動作的顯示時間正確。
- 事件記錄檔符合事件發生的實際時間。
- 排定任務在正確的時間執行。

1. 登入 QSS。

2. 前往 [系統] > [系統設定] > [時間] 。
3. 指定時區。
4. 指定時間設定。

設定	說明
手動設定	指定日期和時間。
與網際網路時間伺服器同步	確認您的裝置已連接網際網路，然後指定下列資訊： 伺服器 ：指定網路時間通訊協定 (NTP) 伺服器。 範例：time.nist.gov、time.windows.com

5. 按一下 [儲存] 。

QSS 隨即更新時間設定。

備份系統設定

1. 登入 QSS 。
2. 前往 [系統] > [系統設定] > [備份與還原] 。
3. 按一下 [備份] 。

該裝置隨即將系統設定以 BIN 檔案匯出並下載到您的電腦。

還原系統設定



警告

如果所選的備份檔案含有裝置中已存在的使用者或使用者群組資訊，則系統將覆寫現有的資訊。

1. 登入 QSS 。
2. 前往 [系統] > [系統設定] > [備份與還原] 。
- 檔案總管視窗隨即開啟。
3. 按一下 [瀏覽] 。
4. 選擇包含裝置系統設定的有效 BIN 檔案。
5. 按一下 [還原] 。

QSS 將會還原交換器設定。

重設交換器密碼

1. 登入 QSS 。
2. 前往 [系統] > [系統設定] > [重設成出廠預設值] 。
3. 按一下 [密碼重設] 。

QSS 隨即重設交換器。

預設使用者名稱	預設密碼
admin	交換器映像的 MAC 位址，請刪去所有標點符號，並將所有字母大寫。  提示 例如，如果 MAC 位址為 00:0a:0b:0c:00:01，預設密碼則為 000A0B0C0001。 您可以透過 Qfinder Pro 找到 MAC 位址，也可在裝置上的貼紙找到「MAC」字樣。

將交換器重設至出廠設定

重設交換器將會刪除此裝置儲存的資料，並將交換器還原至出廠預設值。



提示

您也可按住實體重設按鈕 10 秒鐘，將交換器還原至出廠預設值。

1. 登入 QSS。
2. 前往 [系統] > [系統設定] > [重設成出廠預設值]。
3. 按一下 [重設成出廠預設值]。
隨即顯示確認訊息。
4. 按一下 [是]。

QSS 隨即將交換器重設為出廠設定。



注意

如要再次登入到介面，您必須透過 Qfinder Pro 定位裝置。如需詳細資訊，請參見：[交換器存取](#)。

啟用安全連線 (HTTPS)

1. 登入 QSS。
2. 前往 [系統] > [系統設定] > [HTTPS]。
3. 選擇 [啟用安全連線 (HTTPS)]。
4. 選擇 TLS 版本。



注意

選擇最新版本的 TLS 以盡可能提高系統安全性。確保您的系統滿足 TLS 要求，以避免相容性問題。

5. 選擇性: 選擇 [強制只使用安全連線 (HTTPS)]。



注意

在啟用此設定後，您只能透過 HTTPS 存取網頁管理頁面。

6. 按一下 [儲存]。

QSS 隨即儲存安全連線設定。

重新啟動交換器

1. 登入 QSS。
2. 按一下位於頁面右上角的 。
3. 按一下 **[重新啟動交換器]**。
確認訊息隨即顯示。
4. 按一下 **[是]**。

QSS 隨即重新啟動交換器。

檢視交換器資訊

若要檢視交換器的硬體和系統資訊，請前往 **[系統]** > **[系統資訊]**。

畫面隨即提供下列資訊。

資訊	說明
交換器名稱	顯示裝置的預設名稱或已修改名稱
型號名稱	顯示交換器的型號名稱
MAC 位址	顯示交換器映像檔的 MAC 地址
IP 位址	顯示交換器的 DHCP 或靜態 IP 地址
系統開機累計時間	顯示系統運行的時間
目前韌體版本	顯示交換器的韌體映像檔版本

韌體更新

QNAP 建議隨時更新裝置韌體。如此可確保裝置享有最新 QSS 軟體功能、安全性更新、增強工具和錯誤修正所帶來的益處。

您可以使用下列其中一種方式更新交換器韌體。

更新方式	描述
使用 檢查更新	QSS 會自動偵測韌體更新，並安裝在裝置上。 如需詳細資訊，請參見： 檢查即時更新 。
使用 韌體更新	您可以在 QNAP 網站 上查看韌體更新、下載更新至電腦，然後手動安裝更新到您的裝置上。 如需詳細資訊，請參見： 手動更新韌體 。

韌體需求

裝置應符合以下需求以便執行韌體更新：

設定	需求
硬體設定	<ul style="list-style-type: none"> 電腦 <p> 注意 需要手動使用電腦或經由 Qfinder Pro 來更新韌體。</p> <p>乙太網路線</p> <p> 注意 QNAP 建議使用有線乙太網路連線來更新韌體，確保韌體更新期間網路連結保持穩定。</p>
備份系統設定	QNAP 建議您在更新韌體前，先備份系統設定至電腦。如需詳細資訊，請參見： 備份系統設定 。
管理員權限	您必須是交換器管理員或具備管理員權限才能更新韌體。
停止交換器作業	QNAP 建議您在更新韌體前停止所有其他交換器作業。交換器必須重新啟動，該韌體更新才會生效。在這過程中可能會中斷執行中的交換器服務或作業。
裝置型號	請確認交換器型號正確無誤。您可以使用下列方法找到交換器型號： <ul style="list-style-type: none"> 在裝置底部或背面的貼紙上找到型號。 前往 [控制台] > [系統狀態] > [系統資訊] > [型號名稱]。
韌體版本	如果您透過 韌體更新 或 Qfinder Pro 更新韌體，請確認所選取的韌體版本適用於裝置的型號。

檢查即時更新



警告

- 為避免資料遺失，QNAP 建議您在更新韌體前先備份裝置上的所有資料。如需有關資料備份的詳細資訊，請參閱：[備份系統設定](#)。
- 請勿在韌體更新過程中關閉裝置。



重要

- 在更新韌體之前，請務必閱讀：[韌體需求](#)。
- 視硬體設置和網路連線能力而定，更新過程可能需要數分鐘或更長時間。

- 登入 QSS。
- 前往 **[系統]** > **[韌體更新]** > **[即時更新]**。
- 按一下 **[檢查更新]**。
QSS 隨即檢查可用的韌體更新。如有可用的更新，您可以選擇更新 QSS。
- 按一下 **[更新系統]**。
確認訊息隨即顯示。
- 按一下 **[更新]**。

QSS 將會更新韌體。

手動更新韌體



警告

- 為避免資料遺失，QNAP 建議您在更新韌體前先備份裝置上的所有資料。如需有關資料備份的詳細資訊，請參閱：[備份系統設定](#)。
- 請勿在韌體更新過程中關閉裝置。



重要

- 在更新韌體之前，請務必閱讀：[韌體需求](#)。
- 視硬體設置和網路連線能力而定，更新過程可能需要數分鐘或更長時間。

1. 下載裝置韌體。
 - a. 前往 <http://www.qnap.com/download>。
 - b. 選擇產品類型。
 - c. 選擇裝置型號。
 - d. 閱讀版本說明並確認以下事項：
 - 裝置型號符合韌體版本。
 - 韌體已取得必要更新。
 - 檢查是否有其他韌體更新設定說明。
2. 確認產品型號和韌體正確無誤。
3. 根據您的位置選取下載伺服器。
4. 下載韌體套件。
5. 按一下 [瀏覽]。
6. 選擇資料夾。
7. 儲存下載的韌體套件。
8. 將韌體映像檔解壓縮。
9. 登入 QSS。
10. 前往 [系統] > [韌體更新] > [韌體更新]。
11. 按一下 [瀏覽]，然後選擇解壓縮後的韌體映像檔。
12. 按一下 [更新系統]。
確認訊息視窗隨即出現。
13. 按一下 [更新]。

裝置立即重新啟動。

手動更新韌體



警告

- 為避免資料遺失，QNAP 建議您在更新韌體前先備份裝置上的所有資料。如需有關資料備份的詳細資訊，請參閱：。
- 請勿在韌體更新過程中關閉裝置。



重要

- 請在更新韌體前確定您閱讀「」的完整內容。
- 視硬體設置和網路連線能力而定，更新過程可能需要數分鐘或更長時間。

1. 下載裝置韌體。
 - a. 前往 <http://www.qnap.com/download>。
 - b. 選擇產品類型。
 - c. 選擇裝置型號。
 - d. 閱讀版本說明並確認以下事項：
 - 裝置型號符合韌體版本。
 - 韌體已取得必要更新。
 - 檢查是否有其他韌體更新設定說明。
2. 確認產品型號和韌體正確無誤。
3. 根據您的位置選取下載伺服器。
4. 下載韌體套件。
5. 按一下 [瀏覽]。
6. 選擇資料夾。
7. 儲存下載的韌體套件。
8. 將韌體映像檔解壓縮。
9. 登入 QSS。
10. 前往 [系統管理] > [韌體更新] > [韌體更新]。
11. 前往 [系統] > [韌體更新] > [韌體更新]。
12. 按一下 [瀏覽]，然後選擇解壓縮後的韌體映像檔。
13. 按一下 [更新系統]。
確認訊息視窗隨即出現。
14. 按一下 [更新]。

裝置立即重新啟動。

5. 支援和其他資源

QNAP 提供下列資源：

資源	URL
文件	https://docs.qnap.com
服務入口網站	https://service.qnap.com
下載	https://download.qnap.com
社群論壇	https://forum.qnap.com

6. 詞彙

myQNAPcloud

提供各種遠端存取服務，例如 DDNS 與 myQNAPcloud Link

Qfinder Pro

QNAP 應用工具可讓您定位和存取區域網路內的 QNAP NAS 裝置

QSS

QNAP 交換器管理應用程式

QuNetSwitch

執行 QTS 作業系統的 QNAP 交換器管理應用程式

7. 聲明

本章介紹擔保、免責聲明、授權以及聯邦法規的相關資訊。

有限保固

QNAP 提供有限的產品保固服務。您購買的 QNAP 品牌硬體產品在材料和製造品質上受到瑕疵擔保，擔保期限為發票上所印日期起一 (1) 年或以上。 ("保固期")。請前往 www.qnap.com/warranty 深入瞭解您的法定權利，然 QNAP 得自行酌情隨時予以修改。

免責聲明

本文件所含資訊的適用對象為 QNAP Systems, Inc. (下稱 "QNAP") 之產品。本文件並未以明示、默示、禁反言或其他方式授予任何智慧財產權。除 QNAP 產品銷售條款與條件另有規定外，QNAP 不承擔任何責任，且 QNAP 免除任何與 QNAP 產品銷售及／或使用有關的明示或默示之保固，包括符合特定用途、商業適售性的責任與保固，以及侵害任何專利、版權或其他智慧財產權之行為。

QNAP 產品不適用於醫療、救生、生命維持、重要管制點或安全系統，也不適用於核能設施應用。

在任何情況下，QNAP 對於因使用產品、其隨附軟體或其文件所造成的直接、間接、特殊、附帶或衍生損壞，應負擔的賠償責任不超過本產品的售價。QNAP 對其產品或本文件之內容或應用以及所有隨附軟體，不做任何明示、默示或法定之保證或表述，亦特別聲明，不保證其品質、效能、適售性或適用於任何特定用途。QNAP 保留修訂或更新其產品、軟體或文件的權利，如有變更，恕不另行通知。

建議定期備份系統資料，以避免發生任何資料遺失意外。QNAP 不負責任何資料遺失或復原。

如要把 NAS (網路儲存裝置) 等 QNAP 產品包裝內的任何元件退回，並要求退款或維修，請確定貨品已妥善包裝以利運送。若貨品運送期間因不妥善包裝造成任何損壞，QNAP 一概不予負責。

本公司保留變更產品功能與規格的權利，如有變更，恕不另行通知。本文資訊如有變更，恕不另行通知。

另外，本文省略 ® 或 ™ 符號。

GNU Public License

Version 3, 29 June 2007

Everyone is permitted to copy and distribute verbatim copies of this license document, but changing it is not allowed.

Preamble

The GNU General Public License is a free, copy left license for software and other kinds of works.

The licenses for most software and other practical works are designed to take away your freedom to share and change the works. By contrast, the GNU General Public License is intended to guarantee your freedom to share and change all versions of a program--to make sure it remains free software for all its users. We, the Free Software Foundation, use the GNU General Public License for most of our software; it applies also to any other work released this way by its authors. You can apply it to your programs, too.

When we speak of free software, we are referring to freedom, not price. Our General Public Licenses are designed to make sure that you have the freedom to distribute copies of free software (and charge for them if you wish), that you receive source code or can get it if you want it, that you can change the software or use pieces of it in new free programs, and that you know you can do these things.

To protect your rights, we need to prevent others from denying you these rights or asking you to surrender the rights. Therefore, you have certain responsibilities if you distribute copies of the software, or if you modify it: responsibilities to respect the freedom of others.

For example, if you distribute copies of such a program, whether gratis or for a fee, you must pass on to the recipients the same freedoms that you received. You must make sure that they, too, receive or can get the source code. And you must show them these terms so they know their rights.

Developers that use the GNU GPL protect your rights with two steps: (1) assert copyright on the software, and (2) offer you this License giving you legal permission to copy, distribute and/or modify it.

For the developers' and authors' protection, the GPL clearly explains that there is no warranty for this free software. For both users' and authors' sake, the GPL requires that modified versions be marked as changed, so that their problems will not be attributed erroneously to authors of previous versions.

Some devices are designed to deny users access to install or run modified versions of the software inside them, although the manufacturer can do so. This is fundamentally incompatible with the aim of protecting users' freedom to change the software. The systematic pattern of such abuse occurs in the area of products for individuals to use, which is precisely where it is most unacceptable. Therefore, we have designed this version of the GPL to prohibit the practice for those products. If such problems arise substantially in other domains, we stand ready to extend this provision to those domains in future versions of the GPL, as needed to protect the freedom of users.

Finally, every program is threatened constantly by software patents. States should not allow patents to restrict development and use of software on general-purpose computers, but in those that do, we wish to avoid the special danger that patents applied to a free program could make it effectively proprietary. To prevent this, the GPL assures that patents cannot be used to render the program non-free.

The precise terms and conditions for copying, distribution and modification follow.

Terms and Conditions

1. Definitions.

"This License" refers to version 3 of the GNU General Public License.

"Copyright" also means copyright-like laws that apply to other kinds of works, such as semiconductor masks.

"The Program" refers to any copyrightable work licensed under this License. Each licensee is addressed as "you". "Licensees" and "recipients" may be individuals or organizations.

To "modify" a work means to copy from or adapt all or part of the work in a fashion requiring copyright permission, other than the making of an exact copy. The resulting work is called a "modified version" of the earlier work or a work "based on" the earlier work.

A "covered work" means either the unmodified Program or a work based on the Program.

To "propagate" a work means to do anything with it that, without permission, would make you directly or secondarily liable for infringement under applicable copyright law, except executing it on a computer or modifying a private copy. Propagation includes copying, distribution (with or without modification), making available to the public, and in some countries other activities as well.

To "convey" a work means any kind of propagation that enables other parties to make or receive copies. Mere interaction with a user through a computer network, with no transfer of a copy, is not conveying.

An interactive user interface displays "Appropriate Legal Notices" to the extent that it includes a convenient and prominently visible feature that (1) displays an appropriate copyright notice, and (2) tells the user that there is no warranty for the work (except to the extent that warranties are provided), that licensees may convey the work under this License, and how to view a copy of this License. If the interface presents a list of user commands or options, such as a menu, a prominent item in the list meets this criterion.

2. Source Code.

The “source code” for a work means the preferred form of the work for making modifications to it. “Object code” means any non-source form of a work.

A “Standard Interface” means an interface that either is an official standard defined by a recognized standards body, or, in the case of interfaces specified for a particular programming language, one that is widely used among developers working in that language.

The “System Libraries” of an executable work include anything, other than the work as a whole, that (a) is included in the normal form of packaging a Major Component, but which is not part of that Major Component, and (b) serves only to enable use of the work with that Major Component, or to implement a Standard Interface for which an implementation is available to the public in source code form. A “Major Component”, in this context, means a major essential component (kernel, window system, and so on) of the specific operating system (if any) on which the executable work runs, or a compiler used to produce the work, or an object code interpreter used to run it.

The “Corresponding Source” for a work in object code form means all the source code needed to generate, install, and (for an executable work) run the object code and to modify the work, including scripts to control those activities. However, it does not include the work’s System Libraries, or general-purpose tools or generally available free programs which are used unmodified in performing those activities but which are not part of the work. For example, Corresponding Source includes interface definition files associated with source files for the work, and the source code for shared libraries and dynamically linked subprograms that the work is specifically designed to require, such as by intimate data communication or control flow between those subprograms and other parts of the work.

The Corresponding Source need not include anything that users can regenerate automatically from other parts of the Corresponding Source.

The Corresponding Source for a work in source code form is that same work.

3. Basic Permissions.

All rights granted under this License are granted for the term of copyright on the Program, and are irrevocable provided the stated conditions are met. This License explicitly affirms your unlimited permission to run the unmodified Program. The output from running a covered work is covered by this License only if the output, given its content, constitutes a covered work. This License acknowledges your rights of fair use or other equivalent, as provided by copyright law.

You may make, run and propagate covered works that you do not convey, without conditions so long as your license otherwise remains in force. You may convey covered works to others for the sole purpose of having them make modifications exclusively for you, or provide you with facilities for running those works, provided that you comply with the terms of this License in conveying all material for which you do not control copyright. Those thus making or running the covered works for you must do so exclusively on your behalf, under your direction and control, on terms that prohibit them from making any copies of your copyrighted material outside their relationship with you.

Conveying under any other circumstances is permitted solely under the conditions stated below. Sublicensing is not allowed; section 10 makes it unnecessary.

4. Protecting Users' Legal Rights From Anti-Circumvention Law.

No covered work shall be deemed part of an effective technological measure under any applicable law fulfilling obligations under article 11 of the WIPO copyright treaty adopted on 20 December 1996, or similar laws prohibiting or restricting circumvention of such measures.

When you convey a covered work, you waive any legal power to forbid circumvention of technological measures to the extent such circumvention is effected by exercising rights under this License with respect to the covered work, and you disclaim any intention to limit operation or modification of the work as a means of enforcing, against the work’s users, your or third parties’ legal rights to forbid circumvention of technological measures.

5. Conveying Verbatim Copies.

You may convey verbatim copies of the Program’s source code as you receive it, in any medium, provided that you conspicuously and appropriately publish on each copy an appropriate copyright notice; keep intact all notices stating that this License and any non-permissive terms added in accord with section 7 apply to the code; keep intact all notices of the absence of any warranty; and give all recipients a copy of this License along with the Program.

You may charge any price or no price for each copy that you convey, and you may offer support or warranty protection for a fee.

6. Conveying Modified Source Versions.

You may convey a work based on the Program, or the modifications to produce it from the Program, in the form of source code under the terms of section 4, provided that you also meet all of these conditions:

- a. The work must carry prominent notices stating that you modified it, and giving a relevant date.
- b. The work must carry prominent notices stating that it is released under this License and any conditions added under section 7. This requirement modifies the requirement in section 4 to “keep intact all notices”.
- c. You must license the entire work, as a whole, under this License to anyone who comes into possession of a copy. This License will therefore apply, along with any applicable section 7 additional terms, to the whole of the work, and all its parts, regardless of how they are packaged. This License gives no permission to license the work in any other way, but it does not invalidate such permission if you have separately received it.
- d. If the work has interactive user interfaces, each must display Appropriate Legal Notices; however, if the Program has interactive interfaces that do not display Appropriate Legal Notices, your work need not make them do so.
A compilation of a covered work with other separate and independent works, which are not by their nature extensions of the covered work, and which are not combined with it such as to form a larger program, in or on a volume of a storage or distribution medium, is called an “aggregate” if the compilation and its resulting copyright are not used to limit the access or legal rights of the compilation's users beyond what the individual works permit. Inclusion of a covered work in an aggregate does not cause this License to apply to the other parts of the aggregate.

7. Conveying Non-Source Forms.

You may convey a covered work in object code form under the terms of sections 4 and 5, provided that you also convey the machine-readable Corresponding Source under the terms of this License, in one of these ways:

- a. Convey the object code in, or embodied in, a physical product (including a physical distribution medium), accompanied by the Corresponding Source fixed on a durable physical medium customarily used for software interchange.
- b. Convey the object code in, or embodied in, a physical product (including a physical distribution medium), accompanied by a written offer, valid for at least three years and valid for as long as you offer spare parts or customer support for that product model, to give anyone who possesses the object code either (1) a copy of the Corresponding Source for all the software in the product that is covered by this License, on a durable physical medium customarily used for software interchange, for a price no more than your reasonable cost of physically performing this conveying of source, or (2) access to copy the Corresponding Source from a network server at no charge.
- c. Convey individual copies of the object code with a copy of the written offer to provide the Corresponding Source. This alternative is allowed only occasionally and noncommercially, and only if you received the object code with such an offer, in accord with subsection 6b.
- d. Convey the object code by offering access from a designated place (gratis or for a charge), and offer equivalent access to the Corresponding Source in the same way through the same place at no further charge. You need not require recipients to copy the Corresponding Source along with the object code. If the place to copy the object code is a network server, the Corresponding Source may be on a different server (operated by you or a third party) that supports equivalent copying facilities, provided you maintain clear directions next to the object code saying where to

find the Corresponding Source. Regardless of what server hosts the Corresponding Source, you remain obligated to ensure that it is available for as long as needed to satisfy these requirements.

- e. Convey the object code using peer-to-peer transmission, provided you inform other peers where the object code and Corresponding Source of the work are being offered to the general public at no charge under subsection 6d.

A separable portion of the object code, whose source code is excluded from the Corresponding Source as a System Library, need not be included in conveying the object code work.

A "User Product" is either (1) a "consumer product", which means any tangible personal property which is normally used for personal, family, or household purposes, or (2) anything designed or sold for incorporation into a dwelling. In determining whether a product is a consumer product, doubtful cases shall be resolved in favor of coverage. For a particular product received by a particular user, "normally used" refers to a typical or common use of that class of product, regardless of the status of the particular user or of the way in which the particular user actually uses, or expects or is expected to use, the product. A product is a consumer product regardless of whether the product has substantial commercial, industrial or non-consumer uses, unless such uses represent the only significant mode of use of the product.

"Installation Information" for a User Product means any methods, procedures, authorization keys, or other information required to install and execute modified versions of a covered work in that User Product from a modified version of its Corresponding Source. The information must suffice to ensure that the continued functioning of the modified object code is in no case prevented or interfered with solely because modification has been made.

If you convey an object code work under this section in, or with, or specifically for use in, a User Product, and the conveying occurs as part of a transaction in which the right of possession and use of the User Product is transferred to the recipient in perpetuity or for a fixed term (regardless of how the transaction is characterized), the Corresponding Source conveyed under this section must be accompanied by the Installation Information. But this requirement does not apply if neither you nor any third party retains the ability to install modified object code on the User Product (for example, the work has been installed in ROM).

The requirement to provide Installation Information does not include a requirement to continue to provide support service, warranty, or updates for a work that has been modified or installed by the recipient, or for the User Product in which it has been modified or installed. Access to a network may be denied when the modification itself materially and adversely affects the operation of the network or violates the rules and protocols for communication across the network.

Corresponding Source conveyed, and Installation Information provided, in accord with this section must be in a format that is publicly documented (and with an implementation available to the public in source code form), and must require no special password or key for unpacking, reading or copying.

8. Additional Terms.

"Additional permissions" are terms that supplement the terms of this License by making exceptions from one or more of its conditions. Additional permissions that are applicable to the entire Program shall be treated as though they were included in this License, to the extent that they are valid under applicable law. If additional permissions apply only to part of the Program, that part may be used separately under those permissions, but the entire Program remains governed by this License without regard to the additional permissions.

When you convey a copy of a covered work, you may at your option remove any additional permissions from that copy, or from any part of it. (Additional permissions may be written to require their own removal in certain cases when you modify the work.) You may place additional permissions on material, added by you to a covered work, for which you have or can give appropriate copyright permission.

Notwithstanding any other provision of this License, for material you add to a covered work, you may (if authorized by the copyright holders of that material) supplement the terms of this License with terms:

- a. Disclaiming warranty or limiting liability differently from the terms of sections 15 and 16 of this License; or
- b. Requiring preservation of specified reasonable legal notices or author attributions in that material or in the Appropriate Legal Notices displayed by works containing it; or
- c. Prohibiting misrepresentation of the origin of that material, or requiring that modified versions of such material be marked in reasonable ways as different from the original version; or
- d. Limiting the use for publicity purposes of names of licensors or authors of the material; or
- e. Declining to grant rights under trademark law for use of some trade names, trademarks, or service marks; or
- f. Requiring indemnification of licensors and authors of that material by anyone who conveys the material (or modified versions of it) with contractual assumptions of liability to the recipient, for any liability that these contractual assumptions directly impose on those licensors and authors. All other non-permissive additional terms are considered “further restrictions” within the meaning of section 10. If the Program as you received it, or any part of it, contains a notice stating that it is governed by this License along with a term that is a further restriction, you may remove that term. If a license document contains a further restriction but permits relicensing or conveying under this License, you may add to a covered work material governed by the terms of that license document, provided that the further restriction does not survive such relicensing or conveying.
If you add terms to a covered work in accord with this section, you must place, in the relevant source files, a statement of the additional terms that apply to those files, or a notice indicating where to find the applicable terms.
Additional terms, permissive or non-permissive, may be stated in the form of a separately written license, or stated as exceptions; the above requirements apply either way.

9. Termination.

You may not propagate or modify a covered work except as expressly provided under this License. Any attempt otherwise to propagate or modify it is void, and will automatically terminate your rights under this License (including any patent licenses granted under the third paragraph of section 11).

However, if you cease all violation of this License, then your license from a particular copyright holder is reinstated (a) provisionally, unless and until the copyright holder explicitly and finally terminates your license, and (b) permanently, if the copyright holder fails to notify you of the violation by some reasonable means prior to 60 days after the cessation.

Moreover, your license from a particular copyright holder is reinstated permanently if the copyright holder notifies you of the violation by some reasonable means, this is the first time you have received notice of violation of this License (for any work) from that copyright holder, and you cure the violation prior to 30 days after your receipt of the notice.

Termination of your rights under this section does not terminate the licenses of parties who have received copies or rights from you under this License. If your rights have been terminated and not permanently reinstated, you do not qualify to receive new licenses for the same material under section 10.

10. Acceptance Not Required for Having Copies.

You are not required to accept this License in order to receive or run a copy of the Program. Ancillary propagation of a covered work occurring solely as a consequence of using peer-to-peer transmission to receive a copy likewise does not require acceptance. However, nothing other than this License grants you permission to propagate or modify any covered work. These actions infringe copyright if you do not accept this License. Therefore, by modifying or propagating a covered work, you indicate your acceptance of this License to do so.

11. Automatic Licensing of Downstream Recipients.

Each time you convey a covered work, the recipient automatically receives a license from the original licensors, to run, modify and propagate that work, subject to this License. You are not responsible for enforcing compliance by third parties with this License.

An “entity transaction” is a transaction transferring control of an organization, or substantially all assets of one, or subdividing an organization, or merging organizations. If propagation of a covered work results from an entity transaction, each party to that transaction who receives a copy of the work also receives whatever licenses to the work the party's predecessor in interest had or could give under the previous paragraph, plus a right to possession of the Corresponding Source of the work from the predecessor in interest, if the predecessor has it or can get it with reasonable efforts.

You may not impose any further restrictions on the exercise of the rights granted or affirmed under this License. For example, you may not impose a license fee, royalty, or other charge for exercise of rights granted under this License, and you may not initiate litigation (including a cross-claim or counterclaim in a lawsuit) alleging that any patent claim is infringed by making, using, selling, offering for sale, or importing the Program or any portion of it.

12. Patents.

A “contributor” is a copyright holder who authorizes use under this License of the Program or a work on which the Program is based. The work thus licensed is called the contributor's “contributor version”. A contributor's “essential patent claims” are all patent claims owned or controlled by the contributor, whether already acquired or hereafter acquired, that would be infringed by some manner, permitted by this License, of making, using, or selling its contributor version, but do not include claims that would be infringed only as a consequence of further modification of the contributor version. For purposes of this definition, “control” includes the right to grant patent sublicenses in a manner consistent with the requirements of this License.

Each contributor grants you a non-exclusive, worldwide, royalty-free patent license under the contributor's essential patent claims, to make, use, sell, offer for sale, import and otherwise run, modify and propagate the contents of its contributor version.

In the following three paragraphs, a “patent license” is any express agreement or commitment, however denominated, not to enforce a patent (such as an express permission to practice a patent or covenant not to sue for patent infringement). To “grant” such a patent license to a party means to make such an agreement or commitment not to enforce a patent against the party.

If you convey a covered work, knowingly relying on a patent license, and the Corresponding Source of the work is not available for anyone to copy, free of charge and under the terms of this License, through a publicly available network server or other readily accessible means, then you must either (1) cause the Corresponding Source to be so available, or (2) arrange to deprive yourself of the benefit of the patent license for this particular work, or (3) arrange, in a manner consistent with the requirements of this License, to extend the patent license to downstream recipients. “Knowingly relying” means you have actual knowledge that, but for the patent license, your conveying the covered work in a country, or your recipient's use of the covered work in a country, would infringe one or more identifiable patents in that country that you have reason to believe are valid.

If, pursuant to or in connection with a single transaction or arrangement, you convey, or propagate by procuring conveyance of, a covered work, and grant a patent license to some of the parties receiving the covered work authorizing them to use, propagate, modify or convey a specific copy of the covered work, then the patent license you grant is automatically extended to all recipients of the covered work and works based on it.

A patent license is “discriminatory” if it does not include within the scope of its coverage, prohibits the exercise of, or is conditioned on the non-exercise of one or more of the rights that are specifically granted under this License. You may not convey a covered work if you are a party to an arrangement with a third party that is in the business of distributing software, under which you make payment to the third party based on the extent of your activity of conveying the work, and under which the third party grants, to any of the parties who would receive the covered work from you, a discriminatory patent license (a) in connection with copies of the covered work conveyed by you (or copies made from those copies), or (b) primarily for and in connection with specific products or compilations that contain the covered work, unless you entered into that arrangement, or that patent license was granted, prior to 28 March 2007.

Nothing in this License shall be construed as excluding or limiting any implied license or other defenses to infringement that may otherwise be available to you under applicable patent law.

13. No Surrender of Others' Freedom.

If conditions are imposed on you (whether by court order, agreement or otherwise) that contradict the conditions of this License, they do not excuse you from the conditions of this License. If you cannot convey a covered work so as to satisfy simultaneously your obligations under this License and any other pertinent obligations, then as a consequence you may not convey it at all. For example, if you agree to terms that obligate you to collect a royalty for further conveying from those to whom you convey the Program, the only way you could satisfy both those terms and this License would be to refrain entirely from conveying the Program.

14. Use with the GNU Affero General Public License.

Notwithstanding any other provision of this License, you have permission to link or combine any covered work with a work licensed under version 3 of the GNU Affero General Public License into a single combined work, and to convey the resulting work. The terms of this License will continue to apply to the part which is the covered work, but the special requirements of the GNU Affero General Public License, section 13, concerning interaction through a network will apply to the combination as such.

15. Revised Versions of this License.

The Free Software Foundation may publish revised and/or new versions of the GNU General Public License from time to time. Such new versions will be similar in spirit to the present version, but may differ in detail to address new problems or concerns.

Each version is given a distinguishing version number. If the Program specifies that a certain numbered version of the GNU General Public License “or any later version” applies to it, you have the option of following the terms and conditions either of that numbered version or of any later version published by the Free Software Foundation. If the Program does not specify a version number of the GNU General Public License, you may choose any version ever published by the Free Software Foundation.

If the Program specifies that a proxy can decide which future versions of the GNU General Public License can be used, that proxy's public statement of acceptance of a version permanently authorizes you to choose that version for the Program.

Later license versions may give you additional or different permissions. However, no additional obligations are imposed on any author or copyright holder as a result of your choosing to follow a later version.

16. Disclaimer of Warranty.

THERE IS NO WARRANTY FOR THE PROGRAM, TO THE EXTENT PERMITTED BY APPLICABLE LAW. EXCEPT WHEN OTHERWISE STATED IN WRITING THE COPYRIGHT HOLDERS AND/OR OTHER PARTIES PROVIDE THE PROGRAM “AS IS” WITHOUT WARRANTY OF ANY KIND, EITHER EXPRESSED OR IMPLIED, INCLUDING, BUT NOT LIMITED TO, THE IMPLIED WARRANTIES OF MERCHANTABILITY AND FITNESS FOR A PARTICULAR PURPOSE. THE ENTIRE RISK AS TO THE QUALITY AND PERFORMANCE OF THE PROGRAM IS WITH YOU. SHOULD THE PROGRAM PROVE DEFECTIVE, YOU ASSUME THE COST OF ALL NECESSARY SERVICING, REPAIR OR CORRECTION.

17. Limitation of Liability.

IN NO EVENT UNLESS REQUIRED BY APPLICABLE LAW OR AGREED TO IN WRITING WILL ANY COPYRIGHT HOLDER, OR ANY OTHER PARTY WHO MODIFIES AND/OR CONVEYS THE PROGRAM AS PERMITTED ABOVE, BE LIABLE TO YOU FOR DAMAGES, INCLUDING ANY GENERAL, SPECIAL, INCIDENTAL OR CONSEQUENTIAL DAMAGES ARISING OUT OF THE USE OR INABILITY TO USE THE PROGRAM (INCLUDING BUT NOT LIMITED TO LOSS OF DATA OR DATA BEING RENDERED INACCURATE OR LOSSES SUSTAINED BY YOU OR THIRD PARTIES OR A FAILURE OF THE PROGRAM TO OPERATE WITH ANY OTHER PROGRAMS), EVEN IF SUCH HOLDER OR OTHER PARTY HAS BEEN ADVISED OF THE POSSIBILITY OF SUCH DAMAGES.

18. Interpretation of Sections 16 and 17.

If the disclaimer of warranty and limitation of liability provided above cannot be given local legal effect according to their terms, reviewing courts shall apply local law that most closely approximates an absolute waiver of all civil liability in connection with the Program, unless a warranty or assumption of liability accompanies a copy of the Program in return for a fee.

END OF TERMS AND CONDITIONS

CE 聲明



此裝置符合 CE 規範等級 B。

FCC 聲明

FCC B 級聲明



本產品符合 FCC 規則第 15 部份。產品操作受以下條件限制：

1. 本產品不得造成有害干擾。
2. 本產品必須接受任何接受到的干擾，包含可能造成意外操作的干擾。



注意

本產品已通過測試並符合 FCC 規則第 15 部分 B 級數位裝置之限制。此等限制旨在為家用裝置提供免於有害干擾之合理保護所設計。本產品產生、使用、並可能放射無線電頻率能量，若未依據指示安裝及使用，可能對無線電通訊造成有害干擾。但特定之安裝並不保證免於發生干擾。若本產品對收音機、電視之收訊造成有害干擾（可開關設備之電源確認），建議使用者以下列一種或多種方式改善干擾狀況：

- 重新調整或放置接收天線。
- 增加本產品與接收器之間的距離。
- 將本產品連接到與接收器不同的電源插座上。
- 如需協助，請洽詢經銷商或專業的收音機或電視技術人員。



重要

任何未經過威聯通科技股份有限公司同意，對此產品之修改，可能會讓 FCC 規範授予此使用者操作本裝置的權力變為無效。

VCCI 聲明



VCCI-B

BSMI 聲明**SJ/T 11364-2006**

本产品符合中国 RoHS 标准。以下表格标示此产品中某有毒物质的含量符合中国 RoHS 标准规定的限量要求。

本产品上会附有“环境友好使用期限”的标签，此期限是估算这些物质“不会有泄漏或突变”的年限。本产品可能包含有较短的环境友好使用期限的可替换元件，像是电池或灯管，这些元件将会单独标示出来。

部件名称	有毒有害物质或元素					
	铅 (Pb)	汞 (Hg)	镉 (Cd)	六价铬 (CR(VI))	多溴联苯 (PBB)	多溴二苯醚 (PBDE)
壳体	0	0	0	0	0	0
显示	0	0	0	0	0	0
印刷电路板	0	0	0	0	0	0
金属螺帽	0	0	0	0	0	0
电缆组装	0	0	0	0	0	0
风扇组装	0	0	0	0	0	0
电力供应组装	0	0	0	0	0	0
电池	0	0	0	0	0	0
O: 表示该有毒有害物质在该部件所有物质材料中的含量均在 SJ/T11363-2006 标准规定的限量要求以下。						
X: 表示该有毒有害物质至少在该部件的某一均质材料中的含量超出 SJ/T11363-2006 标准规定的限量要求。						

歐盟廢電子電機設備 (WEEE) 指令 (2002/96/EC)



根據 WEEE 法規的要求，所有 QNAP 品牌的電子產品皆遵守 WEEE 指令規範，為客戶提供以下使用者資訊。

產品或其包裝上的這個標記表示的是，該產品不得與您其他的家庭垃圾一起處理。相反的，它是指將您的垃圾設備交給指定的收集點，使廢棄電器設備得以回收，是您的責任。您在處理垃圾設備時將其分類收集與回收，有助於保護天然資源，並在回收利用時，保護人體健康與環境。有關您可以將垃圾設備放在何處回收的更多資訊，請聯繫您所在城市的辦公室、您購買產品的家庭垃圾處理服務處或商店。

歐盟 RoHS 聲明

本設備遵守歐盟 RoHS 指令 2011/65/EU 有關限制在電氣和電子設備的生產中使用某些有害物質的規定。RoHS 指令限制在電氣和電子設備中使用鉛、汞、鎘、六價鉻、多溴聯苯 (PBB) 和多溴聯苯醚 (PBDE)。

雷射規範聲明

使用光纖可插拔 (SFP) 模組時，請確保通過 CNS 15016-2 或 IEC 60852-1 認證及第 1 類雷射產品。

使用光纖可插拔 (SFP) 模組時，請確保它通過了 CNS 15016-2 或 IEC 60825-1 認證和 1 類激光產品。

UKCA 聲明



本裝置符合在英國銷售產品的 UKCA 要求。